



ImageScan HD

**The X-Ray That Helps
Your Entire Practice Run Better**

Best Image First Time Every Time

- 0.4 mm focal point means that you're getting the sharpest image in the industry.
- Typical power lines can create instability in the output of any x-ray. The ImageScan HD Power Correction assures highly stable and consistent output even above other DC x-rays.

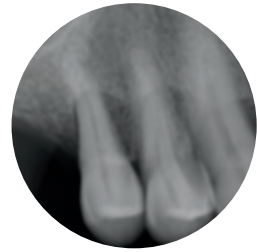

Other Lower Quality X-Ray Systems

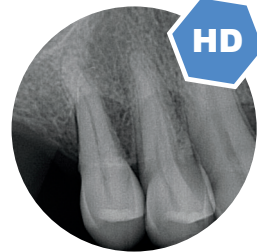

ImageScan HD X-Rays from ImageWorks

Makes the Most of Your Precious Space

- Three arm size options.
- Available in single stud mount, pass through and mobile configurations.

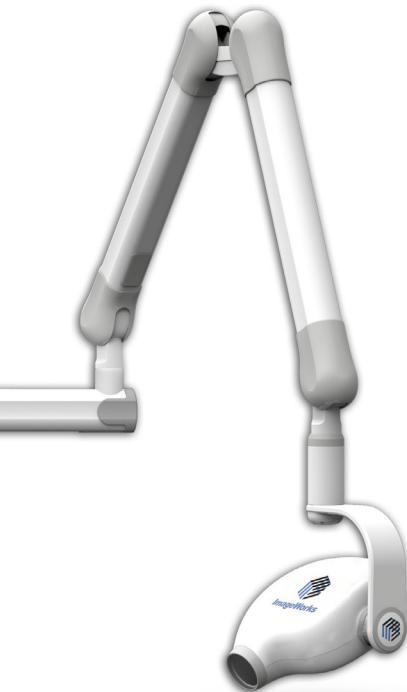

Complete Studies Faster

- Ultra high-precision arm design allows ease of movement and motionless stability.

Reduced Dosage

- Patented shielding creates uniquely low radiation vs. other wall mounted and handheld x-rays.

Rock Solid Quality

- Life cycle tested both mechanically and electrically over 200,000 cycles, assuring the unit will last a long time.



No Need to Train New Staff

The intuitive interface makes operation so simple, even your least-experienced staff member will have no trouble. No training. No mistakes.



ImageScan HD Mobile

All the performance of the wall mounted unit, with the savings of a hand-held x-ray.

- One unit for multiple operatories: Make your x-ray unit work for you by leveraging your investment across many different operatories.
- Easy Installation: No wall mounting or invasive construction work to your office.
- Small Footprint: Compact design fits in many tight spaces.
- Twice the power output of many hand-held x-rays means perfect quality images even if technique is less than perfect.
- Greater operator safety than a hand held x-ray because the operator can leave the room when firing.

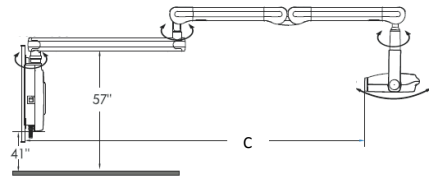
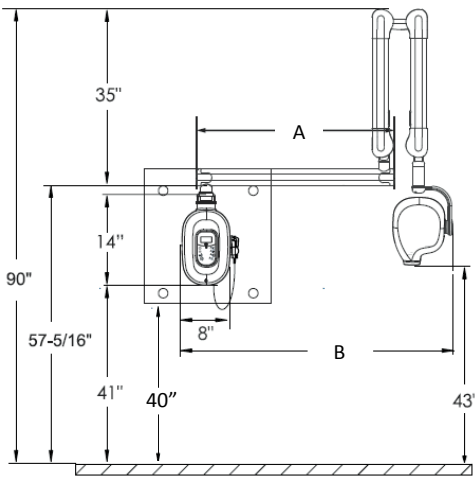

Part Number	Description
9992720200	Wall mounted x-ray with long arm A = 36", B = 47", C = 80"
9992720100	Wall mounted with medium arm A = 28", B = 38", C = 71"
9992720000	Wall mounted with short arm A = 19", B = 29", C = 61"
9992720300	Mobile Unit

Specifications

Line Voltage	110V + 10% 60Hz
Line Current	8 A
Tube Potential	60 to 70 kVp
Tube Current	4 to 8 mA
Exposure Time	0.04-4s
Min. Inherent Filtration	2.5 mm Al Eqv @ 70 kVp
Focal Spot	0.4 mm IEC 60336
Duty Factor	1:15
Ship Wt (Wall Mt)	100 lbs
Ship Wt (Mobile)	170 lbs
Options	Remote Timer, Two Stud Plate

Mobile Unit Basestand

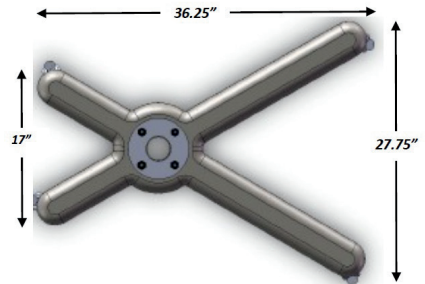

We know that most dentists are also business owners, and as a business owner, you need to make sure you get the best value for your money. For over 35 years, ImageWorks has been manufacturing imaging solutions that provide the best return on investment for dentists.

The ImageWorks Full Dental Imaging End to End Solution



Imaging Software



Digital Intraoral Sensors



Intraoral X-Rays



Panoramic and
Cephalometric X-Rays

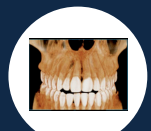

CBCT Systems



Call 914-592-6100 or email Custserv@imageworkscorporation.com

Visit us at www.imageworkscorporation.com