



**CROSSTEX**<sup>®</sup>  
A CANTEL MEDICAL COMPANY

**ACCUTRON**<sup>™</sup>  
Nitrous Oxide/Oxygen Sedation

**COMPLETE NITROUS OXIDE/OXYGEN SEDATION SOLUTIONS  
EQUIPMENT AND ACCESSORIES CATALOG**



## Products

### Flowmeter Systems & Components & Emergency Oxygen Equipment



- Digital Ultra® Flushmount Flowmeter & Accessories ..... 4-5
- Digital Ultra® Flowmeter ..... 6-7
- Digital Newport™ Flowmeter System ..... 7
- Ultra PC® % Cabinet Mount Flowmeter & Accessories ..... 8-9
- Newport™ Flowmeter System ..... 9
- Ultra PC® % Flowmeter ..... 10-11
- Ultra DC® Flowmeter ..... 12-13
- Flowmeter Pre-Installation & Pre-installation Components ..... 14
- Central and Portable System Components ..... 14-15
- Oral Surgery Flowmeter Systems ..... 16-17
- Oral Surgery Accessories ..... 17
- Oral Surgery Suction Accessories ..... 18
- Emergency Oxygen Equipment ..... 18-19

### Manifold Systems & Central System Schematic



- Digi-Flo® Digital Automatic Switching Manifold Systems ..... 20
- Guardian Monitor® Conventional Manifold Systems ..... 21
- Central System Schematic (Gas Cylinder Room) ..... 22-23

### Nasal Masks & Scavenging Systems



- Axess™ Low Profile Masks ..... 24
- Axess™ Scavenging Circuits ..... 25
- ClearView™ Single-Use Nasal Masks ..... 26
- ClearView™ CO<sub>2</sub> Capnography Single-Use Nasal Masks ..... 26
- ClearView™ Scavenging Circuits ..... 27
- ClearView™ Adaptor Easy Order Guide ..... 27
- PIP+® Single-Use Nasal Masks ..... 28
- Multi-Use (steam-sterilizable) Masks ..... 28
- PIP+® Scavenging Circuits ..... 29
- PIP+® Adaptor Easy Order Guide ..... 29

### Miscellaneous Equipment, Components & Accessories



- Vacuum Controllers & Universal Cabinet Slide Mounts ..... 30
- RFS™ Remote Flow System Chairmount Kits ..... 31-33
- Q/C Hoses & Vacuum Male Connectors ..... 33
- Outlet Stations ..... 34
- Digi-Flo® Manifold Accessories & Adapters ..... 35
- Manifold Accessories & Components ..... 35
- Oral Surgery N<sub>2</sub> & O<sub>2</sub> Manifolds & Components ..... 35
- Rubber Goods ..... 36
- Scavenging Circuit Components ..... 36

### Diagrams, Templates & Service/Warranty>Returns

- Axess™, ClearView™ & PIP+® Scavenging Circuit Diagrams ..... 37
- Flowmeter Diagrams & Templates ..... 38-40
- Outlet Templates ..... 41
- Service/Warranty>Returns ..... 42

**Our Promise:**  
 To provide you with a safe and accurate system to relax your patients and monitor their nitrous oxide/oxygen sedation therapy.

Toll-free: 800.531.2221  
 Local Phone: 623.780.2020 • Fax: 623.780.0444  
[www.accutron-inc.com](http://www.accutron-inc.com)



All Accutron products are manufactured in the USA.



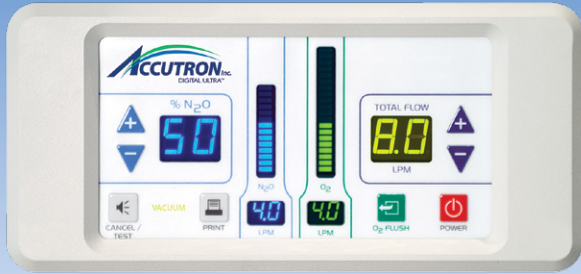

**1 Digital Ultra® Flushmount Flowmeter**

- N<sub>2</sub>O Ratio Control with 70% Max.
- Dual Readouts for Each Gas
- Audible & Visual Low O<sub>2</sub> Alarms
- Oxygen Fail-safe; Oxygen Flush
- Oxygen Resuscitation Connector
- Directional Check Valve
- Emergency Air Valve
- Space-saving Low Profile Unit
- Mounting Options

**Product Specifications**

Dimensions (W x H x D) Flushmount Control Module:	9" x 4" x 1 1/2" 23,5 cm x 10,8 cm x 3,8 cm
Dimensions (W x H x D) Remote Main Module:	8" x 4" x 7 1/2" 18,4 cm x 8,9 cm x 19,1 cm
Mounted Dimensions (W x H x D):	9 1/2" x 4 1/4" x 1/4"
Weight Flushmount Control Module:	1.3 lbs (0.6 kg)
Weight Remote Main Module:	6.1 lbs (2.8 kg)
Mixed Gas Outlet Diameter:	7/8" Nominal (22mm)
Oxygen Inlet:	Male DISS (CGA 1240)
Nitrous Oxide Inlet:	Male DISS (CGA 1040)
Nitrous Oxide Mixed Ratio Range:	0-70%
Oxygen Flow Range:	1.0-9.9 LPM
Nitrous Oxide Flow Range:	0-6.9 LPM
Inlet Pressure (each gas):	50-55 psi
Resuscitator Connector:	Quick Connect (1/4" Imperial) at Remote Outlet
Resuscitator Connector Flow:	100 LPM Oxygen
Power Requirements:	100-240 Volt AC; 50-60 Hz

**Digital Flushmount**

**Central Systems**

**2** 27187  
  
26679

**Bag Tee & Remote Block**

**3**  
  
56855

**RFS™ Remote Flow System D**

**4**  
  
36855

**RFS™ Remote Flow System A**

**5**  
  
56955

**Accu-Vac™ Vacuum Controller**

**6**  
  
43003

**Scavenging Circuit II (Standard)**

**7**  
  
43004

**RFS™-D & Accu-Vac™ Vacuum Controller**

Order No.	Product Description	Retail List
56600	<b>Digital Ultra® Flushmount Package G</b> Digital Ultra® Flushmount Flowmeter, Mounting Hardware, Check Valve Risers, Bag Tee, Scavenging Circuit II (standard) (Includes <b>1 2 6 8</b> )	\$5,918
56800	<b>Digital Ultra® Flushmount Package H</b> Digital Ultra® Flushmount Flowmeter, Mounting Hardware, Check Valve Risers, RFS™ Remote Flow System D (with O <sub>2</sub> port), RFS™ Flush Panel Mount Faceplate, Scavenging Circuit II (for RFS™-D) (Includes <b>1 3 7 8</b> )	\$6,199
56800-CHAIR	<b>Digital Ultra® Flushmount Package H CHAIR</b> Digital Ultra® Flushmount Flowmeter, Mounting Hardware, RFS™ Remote Flow System A, Oxygen Outlet, O <sub>2</sub> and N <sub>2</sub> O Check Valve Risers, 25' of Vacuum Hose, 25' of Mixed Gas Hose, One 6' N <sub>2</sub> O Hose, Two 6' O <sub>2</sub> Hoses, and Scavenging Circuit II (for RFS™-A) (Includes <b>1 4 7 8 9</b> ) <i>Requires separate purchase of appropriate chair brand Chairmount Kit – see pages 31-33 for Chairmount kits</i>	\$6,473
56950	<b>Digital Ultra® Flushmount Package I</b> Digital Ultra® Flushmount Flowmeter, Mounting Hardware, Check Valve Risers, Accu-Vac™ Vacuum Controller, Accu-Vac™ Vacuum Controller Flush Panel Mount Faceplate, Scavenging Circuit II (for Accu-Vac™ Vacuum Controller) (Includes <b>1 5 7 8</b> )	\$6,568

**RFS™  
Chairmount Kits  
for 56800-CHAIR  
on pages 31-33**

*To order Flushmount packages without pre-install kits see page 14. Scavenging Circuit II includes a complimentary sampling of single-use nasal masks.*

## Digital Ultra® Flushmount Flowmeter Accessories

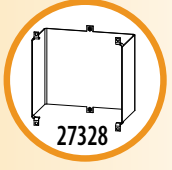

Order No.	Product Description	Retail List
23173-FRU	<b>O<sub>2</sub> Check Valve Riser</b> - DISS (for operatory); includes 28085	\$139
23174-FRU	<b>N<sub>2</sub>O Check Valve Riser</b> - DISS (for operatory); includes 28086	\$139
25043	<b>Universal Light Pole Mount Kit for RFS™ - D</b>	\$176
27193	<b>Bracket for Digital Ultra® Flushmount Flowmeter</b> (use for mounting flowmeter in wall)	\$106
27793	<b>Oxygen Outlet</b> (for use with Digital Ultra® Flushmount, RFS™-A & RFS™ Chairmount Kits)	\$259
27328	<b>Main Module Mounting Bracket</b>	\$68
28085	<b>O<sub>2</sub> DISS x DISS Demand Check Valve Assembly</b>	\$68
28086	<b>N<sub>2</sub>O DISS x DISS Demand Check Valve Assembly</b>	\$68
32015	<b>Universal Cabinet Slide, Accu-Vac™ Vacuum Controller</b> (slide mounts to left, right, or under cabinet)	\$517
32018	<b>Universal Cabinet Slide, Digital RFS™ Remote Flow System</b> (slide mounts to left, right, or under cabinet)	\$517
32019	<b>Universal Cabinet Slide, Digital Bag Tee</b> (slide mounts to left, right, or under cabinet)	\$517
32055	<b>Surface Mount</b> for Digital Ultra® Flushmount	\$219
54500	<b>Remote Control</b> for Digital Ultra® Flowmeter	\$467
54700	<b>O<sub>2</sub> Analyzer</b>	\$501

### Universal Cabinet Slides 3 Cabinet Mounting Positions

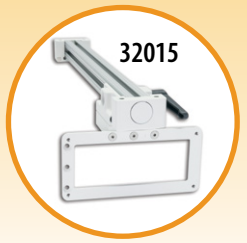
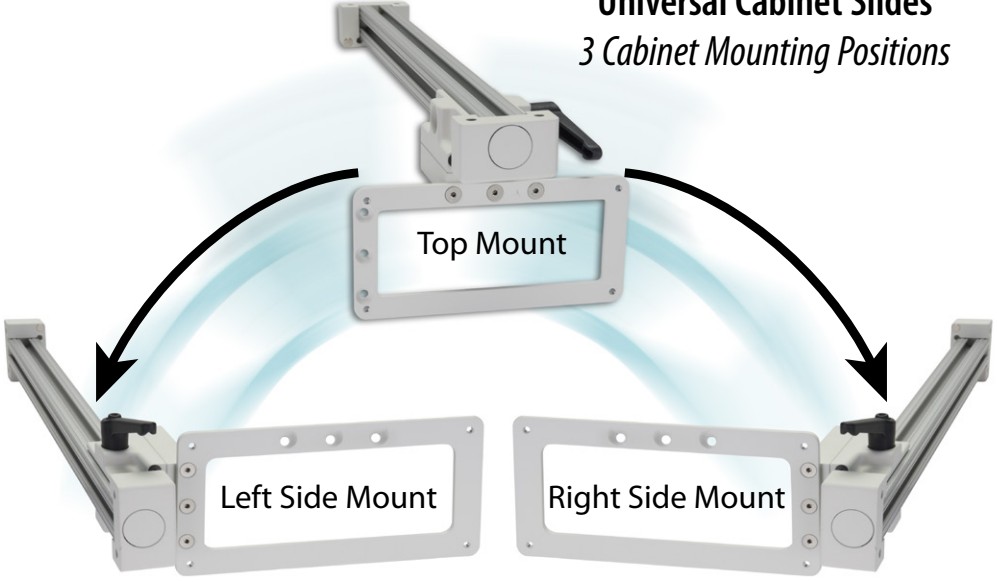

Universal Cabinet Slide, Accu-Vac™



Universal Cabinet Slide, Digital RFS™



Universal Cabinet Slide, Digital Bag Tee



**1 Digital Ultra® Flowmeter**

- N<sub>2</sub>O Ratio Control with 70% Max.
- Dual Readouts for Each Gas
- Audible & Visual Low O<sub>2</sub> Alarms
- Oxygen Fail-safe; Oxygen Flush
- Oxygen Resuscitation Connector
- Directional Check Valve
- Emergency Air Valve

**Product Specifications**

Dimensions (W x H x D):	7 1/2" x 7" x 8 3/4" 19,1 cm x 17,8 cm x 22,2 cm
Weight:	6.3 lbs
Mixed Gas Outlet Diameter:	7/8" Nominal (22mm)
Oxygen Inlet:	Male DISS (CGA 1240)
Nitrous Oxide Inlet:	Male DISS (CGA 1040)
Nitrous Oxide Mixed Ratio Range:	0-70%
Oxygen Flow Range:	1.0-9.9 LPM
Nitrous Oxide Flow Range:	0-6.9 LPM
Inlet Pressure (each gas):	50-55 psi
Resuscitator Connector:	Quick Connect (1/4" Imperial)
Resuscitator Connector Flow:	100 LPM Oxygen
Power Requirements:	100-240 Volt AC; 50-60 Hz

**Digital Control**

**Flowmeter Only**

Order No.	Product Description	Retail List
51975	<b>Digital Ultra® Flowmeter</b> (Includes <b>1</b> )	\$3,752

**Portable Systems**

Order No.	Product Description	Retail List
56100	<b>Digital Ultra® Flowmeter Package B</b> Digital Ultra® Flowmeter 4-Cylinder Portable System Scavenging Circuit II (Includes <b>1</b> <b>2</b> <b>3</b> )	\$7,199

*Scavenging Circuit II includes a complimentary sampling of single-use nasal masks.*



Height with Flowmeter:  
36 3/8"  
W x D (with cylinders):  
22" x 22"

**4-Cylinder Portable System**



**43003**  
**Scavenging Circuit II (Standard)**

## Central Systems

Order No.	Product Description	Retail List
56200	<b>Digital Ultra® Flowmeter Package C</b> Digital Ultra® Flowmeter Mobile Stand & Scavenging Circuit II (Includes 1 3 4)	\$4,750
56200-ADJS	<b>Digital Ultra® Flowmeter Package C ADJS</b> Digital Ultra® Flowmeter Adjustable Mobile Stand – Short Scavenger Circuit II (Includes 1 3 5)	\$ 4,750
56300	<b>Digital Ultra® Flowmeter Package D</b> Digital Ultra® Flowmeter 9-inch Wall Arm & Mounting Adapter 24552 Scavenging Circuit II (Includes 1 3 6)	\$4,750
56400	<b>Digital Ultra® Flowmeter Package E</b> Digital Ultra® Flowmeter 16-inch Bi-fold Wall Arm & Mounting Adapter 24552 Scavenging Circuit II (Includes 1 3 7)	\$4,750
56500	<b>Digital Ultra® Flowmeter Package F</b> Digital Ultra® Flowmeter Telescoping Wall Arm & Mounting Adapter 24552 Scavenging Circuit II (Includes 1 3 8)	\$4,750

Order quick connect hoses for Packages C - F separately (page 33)

See page 34 for a complete listing of Quick Connect Hoses and Vacuum Male Connectors.



Mobile Stand

Height with Flowmeter:  
35 3/4"  
W x D:  
22" x 22"



Adjustable Mobile Stand

Height with Flowmeter:  
26 3/4" – 37 3/4"  
W x D:  
22" x 22"



9" Wall Arm



16" Bi-fold Wall Arm



Telescoping Wall Arm  
(Extends 12"-17")

### 1 Digital Newport™ Flowmeter System



## Digital Portable

### Digital Newport™ Flowmeter System

The **Digital Newport™ Flowmeter System** has all of the operating features of the Digital Ultra® Flowmeter, plus its enclosed 4-cylinder design makes it a user-friendly portable that can easily be moved from operator to operator. The unit's height allows it to be stored under counter space that is open below; if not stored its flat surface can function as additional counter space.

Order No.	Product Description	Retail List
51000	<b>Newport™ Digital Flowmeter System</b> 4-Cylinder Enclosed Portable Scavenging Circuit II (Includes 1 2)	\$8,753



Scavenging Circuit II (Standard)

Accu-Vac™ Vacuum Controller and RFS™ Remote Flow System not available with Newport™ Digital Flowmeter System



**1 Ultra PC® % Cabinet Mount Flowmeter**

- Single-knob Total Flow Control
- N<sub>2</sub>O Ratio Control with 70% Max.
- Oxygen Fail-safe; Oxygen Flush
- Oxygen Resuscitation Connector
- Emergency Air Valve
- Directional Check Valve
- Space-saving Low Profile Unit
- Continuous O<sub>2</sub> & N<sub>2</sub>O Flow Tubes
- Neutral Color

**Product Specifications**

Dimensions (W x H x D):	9 3/4" x 4 3/4" x 3 1/2" 24,8 cm x 12,1 cm x 8,9 cm
Mounted Dimensions (W x H x D):	9 3/4" x 4 3/4" x 1 1/4" 24,8 cm x 12,1 cm x 3,2 cm (to end of knobs) 9 3/4" x 4 3/4" x 1/4" 24,8 cm x 12,1 cm x 0,6 cm (front plate only)
Weight:	6 lb (2.7 kg)
Mixed Gas Outlet Diameter:	7/8" nominal (22 mm)
Oxygen Inlet:	Male DISS (CGA 1240)
Nitrous Oxide Inlet:	Male DISS (CGA 1040)
Nitrous Oxide Mix Ratio Range:	0-70%
Oxygen Flow Range:	1-10 LPM
Nitrous Oxide Flow Range:	0-7 LPM
Inlet Pressure (each gas):	50-55 PSI
Resuscitator Connector:	Quick Connect (1/4" Imperial)
Resuscitator Connector Flow:	100 LPM Oxygen

**RFS™  
Chairmount Kits  
for 36800-CHAIR  
on pages 31-33**

**Percent Cabinet Mount**

**Central Systems**



**2 Bag Tee**

26679



**3 RFS™ Remote Flow System A**

36855



**4 Scavenging Circuit II (Standard)**

43003



**5 Scavenging Circuit II (RFS™-A)**

43004

Order No.	Product Description	Retail List
36600	<b>Ultra PC® % Cabinet Mount Flowmeter Package G</b> Ultra PC® % Cabinet Mount Flowmeter Mounting Hardware, Check Valve Risers, Bag Tee, Scavenging Circuit II (standard) (Includes <b>1 2 4 6</b> )	\$4,999
36800	<b>Ultra PC® % Cabinet Mount Flowmeter Package H</b> Ultra PC® % Cabinet Mount Flowmeter Mounting Hardware, Check Valve Risers, RFS™ Remote Flow System A, Scavenging Circuit II (for RFS™-A) (Includes <b>1 3 5 6</b> )	\$5,399
36800-CHAIR	<b>Ultra PC® % Cabinet Mount Flowmeter Pkg. H CHAIR</b> Ultra PC® % Cabinet Mount Flowmeter, Mounting Hardware, RFS™ Remote Flow System A, O <sub>2</sub> and N <sub>2</sub> O Check Valve Risers, 25' of Vacuum Hose, 25' of Mixed Gas Hose, One 6' N <sub>2</sub> O Hose, One 6' O <sub>2</sub> Hose, and Scavenging Circuit II (for RFS™-A) (Includes <b>1 3 5 6</b> )  <i>Requires separate purchase of appropriate chair brand RFS™ Chairmount Kit – see pages 31-33 for Chairmount kits</i>	\$5,672

*To order above Ultra PC® % Cabinet Mount packages without pre-install kits see page 14.  
Scavenging Circuit II includes a complimentary sampling of single-use nasal masks.*



Ultra PC® % Cabinet Mount Accessories



O<sub>2</sub> & N<sub>2</sub>O  
Check Valve Risers



O<sub>2</sub> DISS & N<sub>2</sub>O DISS x DISS Demand  
Check Valve Assembly

Order No.	Product Description	Retail List
23173-FRU	<b>O<sub>2</sub> Check Valve Riser - DISS includes 28085</b>	\$139
23174-FRU	<b>N<sub>2</sub>O Check Valve Riser - DISS includes 28086</b>	\$139
28085	<b>O<sub>2</sub> DISS x DISS Demand Check Valve Assembly</b>	\$68
28086	<b>N<sub>2</sub>O DISS x DISS Demand Check Valve Assembly</b>	\$68
25043	<b>Universal Light Pole Mount Kit for Remote Flow System (RFS™-A)</b>	\$176
32008	<b>Universal Cabinet Slide, Analog Bag Tee</b> (slide mounts to left, right, or under cabinet)	\$517
32014	<b>Universal Cabinet Slide, Analog RFS™</b> (slide mounts to left, right, or under cabinet)	\$517

Universal Cabinet Slides  
3 Cabinet Mounting Positions

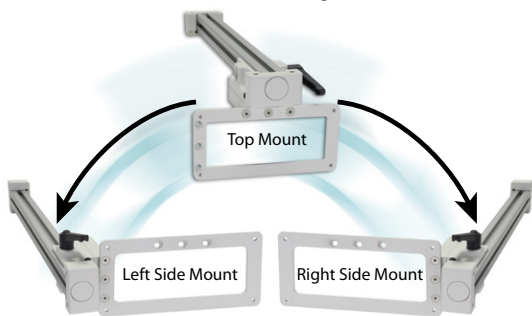

Universal Cabinet Slide, Analog Bag Tee

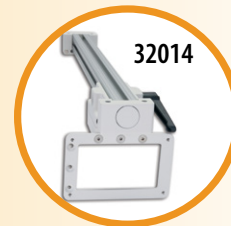

Universal Cabinet Slide, Remote Flow System (RFS™-A)

Percent Portable

Newport™ Flowmeter System

The **Newport™ Flowmeter System** has all of the operating features of the Ultra PC® % flowmeter, plus its enclosed 4-cylinder design makes it a user-friendly portable that can easily be moved from operator to operator. The unit's height allows it to be stored under counter space that is open below; if not stored its flat surface can function as additional counter space.

1 Newport™ Flowmeter System

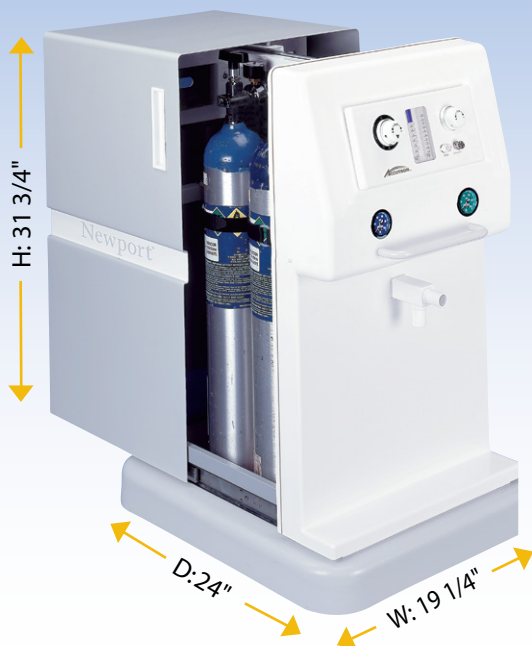

Order No.	Product Description	Retail List
50000	<b>Newport™ Flowmeter System</b> 4-Cylinder Enclosed Portable Scavenging Circuit II (Includes 1 2 )	\$7,876



Scavenging Circuit II (Standard)



- 1 Ultra PC® % Flowmeter**
- Single-knob Total Flow Control
  - N<sub>2</sub>O Ratio Control with 70% Max.
  - Oxygen Fail-safe; Oxygen Flush
  - Oxygen Resuscitation Connector
  - Emergency Air Valve
  - Directional Check Valve
  - DISS Inlet Fittings
  - Neutral Color

**Product Specifications**

Dimensions (W x H x D):	4 1/4" x 10 1/2" x 8" 11 cm x 27 cm x 20 cm
Weight:	4.5 lb (2.0 kg)
Mixed Gas Outlet Diameter:	7/8" nominal (22 mm)
Oxygen Inlet:	Male DISS (CGA-1240)
Nitrous Oxide Inlet:	Male DISS (CGA-1040)
Nitrous Oxide Mix Ratio Range:	0-70%
Oxygen Flow Range:	1-10 LPM
Nitrous Oxide Flow Range:	0-7 LPM
Inlet Pressure (each gas):	50-55 psi
Resuscitator Connector:	Quick Connect (1/4" Imperial)
Resuscitator Connector Flow:	100 LPM Oxygen

**Single-Knob  
Total Flow Control**



Height with Flowmeter:  
39 3/8"  
W x D (with cylinders):  
22" x 22"

**2-Cylinder Portable System**



Height with Flowmeter:  
min: 31 3/8"  
max: 41 3/8"  
W x D (with cylinders):  
22" x 22"

**4-Cylinder Portable System**



43003

**Scavenging Circuit II**

**Flowmeter Only**

Order No.	Product Description	Retail List
31975	<b>Ultra PC® % Flowmeter</b> (Includes <b>1</b> )	\$2,875

**Portable Systems**

Order No.	Product Description	Retail List
36000	<b>Ultra PC® % Flowmeter Package A</b> Ultra PC® % Flowmeter 2-Cylinder Portable System Scavenging Circuit II (Includes <b>1 2 4</b> )	\$5,691
36100	<b>Ultra PC® % Flowmeter Package B</b> Ultra PC® % Flowmeter 4-Cylinder Portable System Scavenging Circuit II (Includes <b>1 3 4</b> )	\$6,270

See Newport™ Flowmeter System on page 9.

Scavenging Circuit II includes a complimentary sampling of single-use nasal masks.

## Central Systems



5

32005

Height with Flowmeter:  
39 1/4"  
W x D:  
22" x 22"

Mobile Stand



6

42005

Height with Flowmeter:  
26 3/4" - 40 3/4"  
W x D:  
22" x 22"

Adjustable Mobile Stand



7

32002

9" Wall Arm



8

32001

16" Bi-fold Wall Arm



9

32003

Telescoping Wall Arm  
(Extends 12"-17")



10

32004

Universal Cabinet Slide, Ultra PC® % & Ultra DC® Flowmeters

Order No.	Product Description	Retail List
36200	<b>Ultra PC® % Flowmeter Package C</b> Ultra PC® % Flowmeter Mobile Stand Scavenging Circuit II (Includes 1 4 5)	\$3,978
36200-ADJS	<b>Ultra PC® % Flowmeter Package C ADJS</b> Ultra PC® % Flowmeter Adjustable Mobile Stand – Short Scavenger Circuit II (Includes 1 4 6)	\$3,978
36300	<b>Ultra PC® % Flowmeter Package D</b> Ultra PC® % Flowmeter 9-inch Wall Arm & Mounting Adapter 24552 Scavenging Circuit II (Includes 1 4 7)	\$3,978
36400	<b>Ultra PC® % Flowmeter Package E</b> Ultra PC® % Flowmeter 16-inch Bi-fold Wall Arm & Mounting Adapter 24552 Scavenging Circuit II (Includes 1 4 8)	\$3,978
36500	<b>Ultra PC® % Flowmeter Package F</b> Ultra PC® % Flowmeter Telescoping Wall Arm & Mounting Adapter 24552 Scavenging Circuit II (Includes 1 4 9)	\$3,978
36500-US	<b>Ultra PC® % Flowmeter Package U</b> Ultra PC® % Flowmeter Universal Cabinet Slide, PC/DC (slide mounts to left, right, or under cabinet), and Mounting Adapter 24552 Scavenging Circuit II (Includes 1 4 10)	\$3,978

Order quick connect hoses for Packages C - F separately (page 33)

Additional mounts on pages 14 & 15.

See page 33 for a complete listing of Quick Connect Hoses and Vacuum Male Connectors.

### Universal Cabinet Slides, Ultra PC® % & Ultra DC® Flowmeters 3 Cabinet Mounting Positions

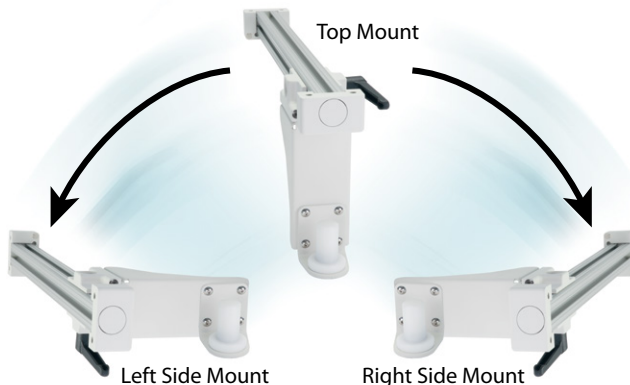



**1 Ultra DC® Flowmeter**

- O<sub>2</sub> Control with On/Off Switch
- Independent O<sub>2</sub> & N<sub>2</sub>O Controls
- Oxygen Fail-Safe; Oxygen Flush
- Oxygen Resuscitation Connector
- Emergency Air Valve
- Directional Check Valve
- DISS Inlet Fittings
- Neutral Color

**Product Specifications**

Dimensions (W x H x D):	4 1/4" x 10 1/2" x 8" 11 cm x 27 cm x 20 cm
Weight:	4.5 lb (2.0 kg)
Mixed Gas Outlet Diameter:	7/8" nominal (22 mm)
Oxygen Inlet:	Male DISS (CGA-1240)
Nitrous Oxide Inlet:	Male DISS (CGA-1040)
Oxygen Flow Range:	3-10 LPM
Nitrous Oxide Flow Range:	0-7 LPM
Inlet Pressure (each gas):	50-55 psi
Resuscitator Connector:	Quick Connect (1/4" Imperial)
Resuscitator Connector Flow:	100 LPM Oxygen

# Independent O<sub>2</sub> & N<sub>2</sub>O Flow Control



2

Height with Flowmeter:  
39 3/8"  
W x D (with cylinders):  
22" x 22"

**2-Cylinder Portable System**



3

Height with Flowmeter:  
min: 31 3/8"  
max: 41 3/8"  
W x D (with cylinders):  
22" x 22"

**4-Cylinder Portable System**



4

43003

**Scavenging Circuit II**

## Flowmeter Only

Order No.	Product Description	Retail List
31980	<b>Ultra DC® Flowmeter</b> (Includes <b>1</b> )	\$2,040

## Portable Systems

Order No.	Product Description	Retail List
46000	<b>Ultra DC® Flowmeter Package A</b> Ultra DC® Flowmeter 2-Cylinder Portable System Scavenging Circuit II (Includes <b>1 2 4</b> )	\$4,752
46100	<b>Ultra DC® Flowmeter Package B</b> Ultra DC® Flowmeter 4-Cylinder Portable System Scavenging Circuit II (Includes <b>1 3 4</b> )	\$5,376

*Scavenging Circuit II includes a complimentary sampling of single-use nasal masks.*

## Central Systems



5

32005

Height with Flowmeter:  
39 1/4"  
W x D:  
22" x 22"

Mobile Stand

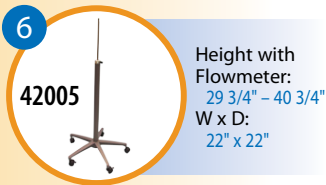

6

42005

Height with Flowmeter:  
29 3/4" - 40 3/4"  
W x D:  
22" x 22"

Adjustable Mobile Stand



7

32002

9" Wall Arm



8

32001

16" Bi-fold Wall Arm



9

32003

Telescoping Wall Arm  
(Extends 12"-17")



10

32004

Universal Cabinet Slide, Ultra PC® %  
& Ultra DC® Flowmeters

Order No.	Product Description	Retail List
46200	<b>Ultra DC® Flowmeter Package C</b> Ultra DC® Flowmeter Mobile Stand Scavenging Circuit II (Includes 1 4 5)	\$3,127
46200-ADJS	<b>Ultra DC® Flowmeter Package C ADJS</b> Ultra DC® Flowmeter Adjustable Mobile Stand – Short Scavenger Circuit II (Includes 1 4 6)	\$ 3,127
46300	<b>Ultra DC® Flowmeter Package D</b> Ultra DC® Flowmeter 9-inch Wall Arm & Mounting Adapter 24552 Scavenging Circuit II (Includes 1 4 7)	\$3,127
46400	<b>Ultra DC® Flowmeter Package E</b> Ultra DC® Flowmeter 16-inch Bi-fold Wall Arm & Mounting Adapter 24552 Scavenging Circuit II (Includes 1 4 8)	\$3,127
46500	<b>Ultra DC® Flowmeter Package F</b> Ultra DC® Flowmeter Telescoping Wall Arm & Mounting Adapter 24552 Scavenging Circuit II (Includes 1 4 9)	\$3,127
46500-US	<b>Ultra DC® Flowmeter Package U</b> Ultra DC® Flowmeter Universal Cabinet Slide, PC/DC (slide mounts to left, right, or under cabinet), and Mounting Adapter 24552 Scavenging Circuit II (Includes 1 4 10)	\$3,127

Order quick connect hoses for Packages C - U separately (page 33)

Additional mounts on pages 14 & 15.

See page 33 for a complete listing of Quick Connect Hoses and Vacuum Male Connectors.

### Universal Cabinet Slides, Ultra PC® % & Ultra DC® Flowmeters 3 Cabinet Mounting Positions

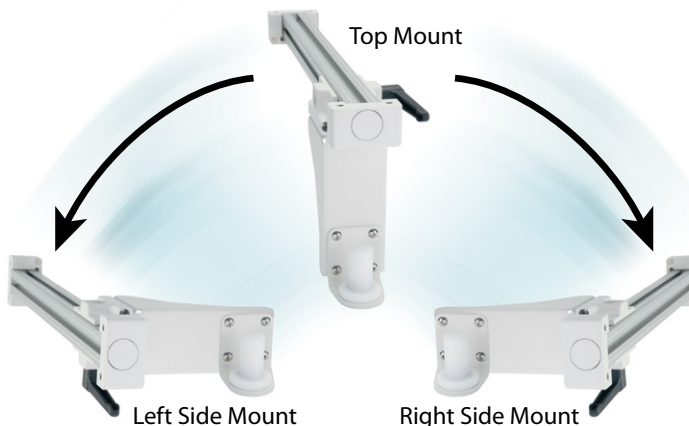



Ultra PC® % Cabinet Mount Flowmeter



Digital Ultra® Flushmount Flowmeter



## Flowmeters without Pre-installation Kits

Order No.	Product Description	Retail List
<b>Cabinet Mount Flowmeters (without pre-installation kits):</b>		
36600-NS	Ultra PC® % Cabinet Mount Flowmeter Pkg. G (includes mounting hardware)	\$4,766
36800-NS	Ultra PC® % Cabinet Mount Flowmeter Pkg. H (includes RFS™ Remote Flow System & mounting hardware)	\$5,173
<b>Digital Flushmount Flowmeters (without pre-installation kits):</b>		
56600-NS	Digital Ultra® Flushmount Flowmeter Pkg. G (includes mounting hardware)	\$5,637
56800-NS	Digital Ultra® Flushmount Flowmeter Pkg. H (includes mounting hardware, Remote Flow System & RFS™ Flush Mount Faceplate)	\$5,972
56950-NS	Digital Ultra® Flushmount Flowmeter Pkg. I (includes mounting hardware, Accu-Vac™ Vacuum Controller & Accu-Vac™ Flush Mount Faceplate)	\$6,287

## Flowmeter Pre-installation Kit Components

Order No.	Product Description	Retail List
<b>Pre-Installation Components:</b>		
23173-FRU	O <sub>2</sub> Check Valve Riser - DISS (for operator); includes 28085	\$139
23174-FRU	N <sub>2</sub> O Check Valve Riser - DISS (for operator); includes 28086	\$139
28085	O <sub>2</sub> DISS x DISS Demand Check Valve Assembly	\$68
28086	N <sub>2</sub> O DISS x DISS Demand Check Valve Assembly	\$68

## Central System Operator Components & Accessories

Order No.	Product Description	Retail List
<b>Digital Ultra® Flowmeter Accessories:</b>		
54500	Remote Control for Digital Ultra® Flowmeter	\$467
54600	Printer for Digital Ultra® Flowmeter	\$625
54650	Printer Paper for Digital Ultra® Flowmeter (10 rolls)	\$59
54700	O <sub>2</sub> Analyzer	\$501
<b>Flowmeter Mounts:</b>		
24552	Mounting Adapter for Flowmeters (replacement)	\$71
32001	16" Bi-fold Wall Arm & Mounting Adapter 24552	\$439
32002	9" Wall Arm & Mounting Adapter 24552	\$410
32003	Telescoping Wall Arm (extends 12" - 17") & Mounting Adapter 24552	\$433
32004	Universal Cabinet Slide, PC/DC (slide mounts to left, right, or under cabinet), includes Mounting Adapter 24552	\$517

## Central System Operatory Components & Accessories (continued)



Order No.	Product Description	Retail List
<b>Flowmeter Mounts (continued):</b>		
32005	Mobile Stand (W x D: 22" x 22" H: 31 1/2")	\$439
32010	Portable and Mobile Stand Adaptor – Digital Ultra®, Ultra PC® % & Ultra DC® Flowmeters to Porter™ Flowmeter	\$65
32011	Wall Arm Adaptor – Ultra to Matrix® Wall Arms	\$65
32021	Wall Bracket with Flowmeter Mounting Post	\$225
32055	Surface Mount for Digital Ultra® Flushmount (flowmeter not included)	\$219
42005	Adjustable Mobile Stand – Short (W x D: 22" x 22" H: 19 1/2" - 30")	\$439

## Portable System Manifolds & Components

Order No.	Product Description	Retail List
20107	E Cylinder Wrench	\$21
24494	Replacement E Washers (pkg. of 10)	\$23
24549	E Yoke Handle	\$38
32010	Portable and Mobile Stand Adaptor – Accutron™ Digital Ultra®, Ultra PC® % & Ultra DC® Flowmeters to Porter™ Flowmeter	\$65
42000	2-Cylinder Non-Digital Portable Manifold	\$2,337
44000	4-Cylinder Non-Digital Portable Manifold	\$3,064





**Digital Ultra® Flowmeter**



**Digital Ultra® Flushmount Flowmeter**



**Adult full facemask, Hanks elbow with pop-off, directional Y valve & corrugated tube**



**Scavenging Circuit II**

## Digital Ultra® Oral Surgery Flowmeter

Order No.	Product Description		Retail List
56100-OS	<b>Portable Packages</b> 4-Cylinder Portable (includes portable manifold) Height with Flowmeter: 36 3/8" W x D: 22" x 22"	1 3 4	\$8,666
56200-OS	<b>Central Packages</b> Mobile Stand Height with Flowmeter: 36 3/8" W x D: 22" x 22"	1 3 4	\$5,914
56200-OS-ADJT	Adjustable Mobile Stand – Tall Height with Flowmeter: 36 3/8" - 47 3/8" W x D: 22" x 22"	3 4 5	\$5,914
56300-OS	9" Wall Arm	1 3 4	\$5,914
56400-OS	16" Bi-fold Wall Arm	1 3 4	\$5,914
56500-OS	Telescoping Wall Arm	1 3 4	\$5,914
56600-OS	Flushmount	2 3 4	\$7,081

## Ultra PC® % Oral Surgery Flowmeter

Order No.	Product Description		Retail List
36000-OS	<b>Portable Packages</b> 2-Cylinder Portable (includes portable manifold) Height with Flowmeter: 39 3/8" W x D: 22" x 22"	3 4 5	\$6,854
36100-OS	4-Cylinder Portable (includes portable manifold) Height with Flowmeter: 39 3/8" W x D: 22" x 22"	3 4 5	\$7,541
36200-OS	<b>Central Packages</b> Mobile Stand Height with Flowmeter: 39 3/8" W x D: 22" x 22"	3 4 5	\$5,142
36200-OS-ADJT	Adjustable Mobile Stand – Tall Height with Flowmeter: 39 3/8" - x 50 3/8" W x D: 22" x 22"	3 4 5	\$5,142
36300-OS	9" Wall Arm	3 4 5	\$5,142
36400-OS	16" Bi-fold Wall Arm	3 4 5	\$5,142
36500-OS	Telescoping Wall Arm	3 4 5	\$5,142
36600-OS	Cabinet Mount	3 4 5	\$6,210



**Ultra PC® % Flowmeter**



**Ultra PC® % Cabinet Mount Flowmeter**





Ultra DC® Flowmeter

## Ultra DC® Oral Surgery Flowmeter

Order No.	Product Description	Retail List
46000-OS	<b>Portable Packages</b> 2-Cylinder Portable (includes portable manifold) Height with Flowmeter: 39 3/8" W x D: 22" x 22"	3 4 7 \$5,915
46100-OS	4-Cylinder Portable (includes portable manifold) Height with Flowmeter: 39 3/8" W x D: 22" x 22"	3 4 7 \$6,539
46200-OS	<b>Central Packages</b> Mobile Stand Height with Flowmeter: 39 3/8" W x D: 22" x 22"	3 4 7 \$4,289
46200-OS-ADJT	Adjustable Mobile Stand – Tall Height with Flowmeter: 39 3/8" - 50 3/8" W x D: 22" x 22"	3 4 7 \$4,289
46300-OS	9" Wall Arm	3 4 7 \$4,289
46400-OS	16" Bi-fold Wall Arm	3 4 7 \$4,289
46500-OS	Telescoping Wall Arm	3 4 7 \$4,289

## Oral Surgery Accessories

Order No.	Product Description	Retail List
47000	Oral Surgery Accessories Package	\$1,163
23854	Universal Female Adapter (22 mm male x 15 mm female)	\$22
47050	Directional Y Valve	\$715
47075	Hanks Elbow with Pop-off	\$322
33014	Corrugated Tube – 3-foot Grey	\$50
22137	Corrugated Tube – 6-Foot Grey	\$75
33029-10	Pediatric Cannula with 7' Tubing (pkg. of 10)	\$80
33030-10	Adult Cannula with 7' Tubing (pkg. of 10)	\$80
38008	Full Facemask – Adult	\$86
38009	Full Facemask – Child	\$86
42006	Adjustable Mobile Stand - Tall H: 28 1/4" - 40" W x D: 22" x 22"	\$489
43034-9	CO <sub>2</sub> Capnography Single-Use Nasal Masks - Large Adult Unscented Grey (pkg. of 12)	\$100
43034-16	CO <sub>2</sub> Capnography Single-Use Nasal Masks - Large Adult Fresh Mint	\$100
43035-9	CO <sub>2</sub> Capnography Single-Use Nasal Masks - Adult Unscented (pkg. of 12)	\$100
43035-14	CO <sub>2</sub> Capnography Single-Use Nasal Masks - Adult Vanilla (pkg. of 12)	\$100
43037-9	CO <sub>2</sub> Capnography Single-Use Nasal Masks - Pediatric Unscented (pkg. of 12)	\$100
43037-12	CO <sub>2</sub> Capnography Single-Use Nasal Masks - Pediatric Bubblegum (pkg. of 12)	\$100

See Oral Surgery Nitrogen and Oxygen Manifold Systems and Manifold Components on pages 35.



Rubber Goods are  
Not made with natural  
rubber latex





## Oral Surgery Suction Accessories

Order No.	Product Description	Retail List
34014	Surgical E-Vac Kit Includes: Five 1500 ml single-use canisters, wall mount plate and mounting hardware (requires vacuum outlet 34011)	\$1,227
34016	Replacement Canisters for Surgical E-Vac Kit Includes: Five 1500 ml single-use canisters	\$88
26986	6' Tubing – 3/8" ID, Clear PVC	\$44
26987	Canister Holder	\$56
26988	Vacuum Regulator	\$551
34017	Vacuum Regulator Mounting Bracket (for 26988)	\$98
26989	Vacuum Slide	\$78
34011	Recessed Q/C Vacuum Outlet	\$271



## Emergency Oxygen Equipment

Order No.	Product Description	Retail List
38013	Deluxe Portable Oxygen System Includes: Demand Valve with O <sub>2</sub> Q/C Fitting, Adult Facemask, Adjustable Liter Flow Regulator, In-line O <sub>2</sub> Adapter, Cylinder Wrench, & Cart (gas cylinder not included)	\$1,599
38010	Portable Oxygen System Includes: Demand Valve with O <sub>2</sub> Q/C Fitting, Adult Facemask, Cylinder Wrench, & Cart (gas cylinder not included)	\$1,300
38006	Portable Oxygen System Includes: Bag, Valve, Mask (Manual Resuscitator), Oxygen Tube, Cylinder Wrench, & Cart (gas cylinder not included)	\$843
38011	Demand Valve Resuscitator Includes: Demand Valve, 6' O <sub>2</sub> Hose, O <sub>2</sub> Male Q/C Fitting	\$769
38007	Manual Resuscitator with Bag, Valve, Mask & Oxygen Tube	\$313
38008	Full Facemask – Adult Replacement part for Demand Valve, Manual Resuscitator & Oral Surgery System	\$86
38009	Full Facemask – Child Replacement part for Demand Valve, Manual Resuscitator & Oral Surgery System	\$86
20526	E Cylinder Mobile Cart	\$234
35018	Deluxe E Yoke Regulator with Adjustable Liter Flow O <sub>2</sub> Fitting, DISS Fitting, Cylinder Content Gauge	\$585
35013	E Yoke Regulator with DISS Fitting and Cylinder Content Gauge	\$469
23551	E Yoke Regulator with Flow Control Knob	\$469

## Emergency Oxygen Equipment (continued)

Order No.	Product Description	Retail List
24589	Oxygen DISS with O <sub>2</sub> Barb Fitting (green nut & nipple)	\$7
35014-U	Oxygen Liter-Flow (for use with oxygen outlets that do not have a hex nut)	\$152
34018	Oxygen Liter-Flow Mounting Bracket (for 35014-U)	\$98
35014-HL	Oxygen Liter-Flow Meter (for use with oxygen outlets that have a hex nut, including stand-alone outlet 27793)	\$152
35015	Oxygen Liter-flow Selector Valve with Bracket (0-15 lpm) with O <sub>2</sub> Barb & O <sub>2</sub> Q/C Fitting (p/n 27775)	\$629
35016	Oxygen Liter-flow Selector Valve without Bracket (0-15 lpm) with O <sub>2</sub> Barb & O <sub>2</sub> Q/C Fitting (p/n 27958)	\$629
35017	Oxygen Liter-flow Selector Valve with 90° Ell (0-15 lpm) with O <sub>2</sub> Barb, Set-up for RFS™- D Remote Flow System D	\$629
26849	Oxygen Fitting – DISS with Female Q/C	\$92
27253	Oxygen Fitting – DISS with Male Q/C with Bracket	\$92
27254	Oxygen Fitting – DISS with Male Q/C without Bracket	\$92
27775	Oxygen Fitting – 1/8" Male Pipe Thread with Male Q/C with Bracket	\$92
27958	Oxygen Fitting – 1/8" Male Pipe Thread with Male Q/C without Bracket	\$92
27793	Oxygen Outlet – DISS with Female Q/C	\$259
33029-10	Pediatric Nasal Cannula with 7' Tubing (curved tips; *Non-Latex; 10 per pkg.)	\$80
33030-10	Adult Nasal Cannula with 7' Tubing (curved tips; *Non-Latex; 10 per pkg.)	\$80

\*Not made with natural rubber latex

### Oxygen Male Q/C (MQC) Chart

Connectors / Outlets	O <sub>2</sub> Outlet	Micro O <sub>2</sub>	Micro Double	Micro Triple	RFS™-A	RFS™-D	Accu-Vac™	Ultra PC® CM	Ultra PC®/DC®	Newport™
O <sub>2</sub> DISS x MQC w/ Bracket p/n 27253		x			x	x	x	x	x	
1/8" MPT x MQC w/ Bracket p/n 27775		x			x	x*	x	x	x	
O <sub>2</sub> DISS x MQC w/o Bracket p/n 27254	x	x	x	x	x	x	x	x	x	x
1/8" MPT x MQC w/o Bracket p/n 27958	x	x	x	x	x	x	x	x	x	x

\* Note: 35017 O<sub>2</sub> Selector Valve can be attached to system if bag tee is removed, or adding a 90° "ell" and nipple will angle Selector Valve up and out of the way of the bag tee.



## Digital Automatic Manifold/Alarm System

Pre-install mounting bracket allows effortless installation!

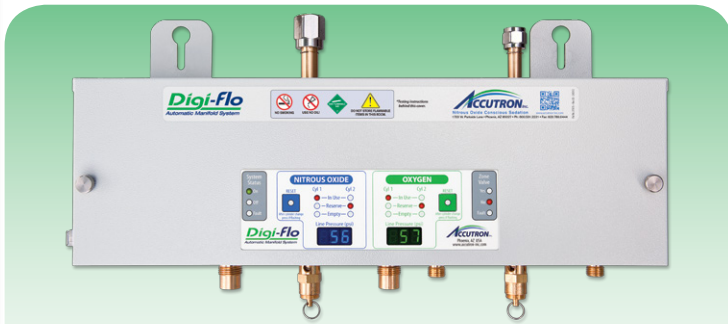

- Automatic cylinder changeover
- Alarm with audio and visual warnings
- Single or multiple zone valve and/or alarm panel capacity
- Clear and precise LED numeric line pressure readings
- Easily accessible components; field upgradeable software
- Optional conduit adapter box available if local codes require wiring inside conduit

### Product Specifications

Dimensions with Cover:	18" x 9" x 3" 46 cm x 23 cm x 8 cm
Working Pressure:	50-55 psi
Hose Length:	4 ft.
N2O Outlet:	N <sub>2</sub> O DISS
O2 Outlet:	O <sub>2</sub> DISS
Primary Voltage:	120 volts
Cable:	Category 6, Shielded, Ethernet 4 twisted pr.,

### Digi-Flo® Manifolds and Valves with Pre-Install Kits

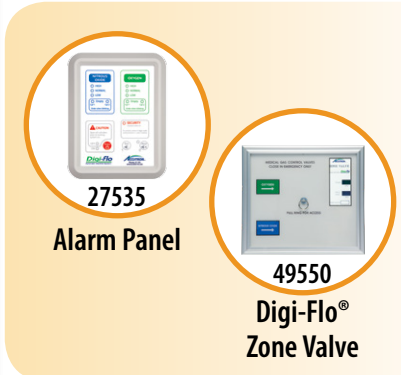

27535  
Alarm Panel

49550  
Digi-Flo®  
Zone Valve

Zone Valve required when in remote location.

**Manifold Package Contents:**  
Manifold with pressure gauges & high/low pressure alarm switches, system indicator panel, 4 cylinder regulators (2 O<sub>2</sub> & 2 N<sub>2</sub>O), four 4 ft. DISS hoses (2 O<sub>2</sub> & 2 N<sub>2</sub>O), wall or desk office control panel, cylinder restraints and optional security system.

Order No.	Product Description	Retail List
49150	<b>Digi-Flo® Automatic Switching Manifold/Alarm Pkg. A - Desk Alarm Panel</b> (includes pre-install kit)	\$6,075
49250	<b>Digi-Flo® Automatic Switching Manifold/Alarm Pkg. B - Wall Alarm Panel</b> (includes pre-install kit)	\$6,075
49350	<b>Digi-Flo® Automatic Switching Manifold/Alarm Pkg. C - Desk Alarm Panel &amp; Security System</b> (includes pre-install kit)	\$6,781
49450	<b>Digi-Flo® Automatic Switching Manifold/Alarm Pkg. D - Wall Alarm Panel &amp; Security System</b> (includes pre-install kit)	\$6,781
49550	<b>Digi-Flo® Zone Valve</b>	\$1,489
27985-FRU	<b>Digi-Flo® Optional Conduit Kit</b>	\$276
27954-FRU	<b>Matrx® Manifold Adapter Kit</b>	\$110

See page 35 for other manifold components.

### Digi-Flo® Manifolds and Alarms without Pre-Install Kits

Order No.	Product Description	Retail List
49150-NP	Manifold with Desk Alarm Panel Pkg. A	\$5,855
49250-NP	Manifold with Wall Alarm Panel Pkg. B	\$5,855
49350-NP	Manifold with Desk Alarm Panel & Security System Pkg. C	\$6,560
49450-NP	Manifold with Wall Alarm Panel & Security System Pkg. D	\$6,560

### Digi-Flo® Manifold Pre-Install Kits

Order No.	Product Description	Retail List
49051	Pre-installation Kit for Digi-Flo® Automatic Manifold Pkgs. A & C Contents: Manifold template, manifold mounting plate assembly with brass risers, 100 ft. cable, wall outlet box for desk alarm panel connection	\$221
49052	Pre-installation Kit for Digi-Flo® Automatic Manifold Pkgs. B & D Contents: Manifold template, manifold Mounting plate assembly with brass risers, 100 ft. cable, outlet box and mounting bracket for wall alarm panel	\$221
49053	Pre-Install Kit for Digi-Flo® 2nd Wall Alarm	\$110
49054	Digi-Flo® 2nd Wall Alarm (includes splinter for 2nd alarm)	\$772
49054-S	Digi-Flo® 2nd Wall Alarm with Security System (includes splinter for 2nd alarm)	\$827



## Guardian Monitor® Conventional Manifold/ Alarm System

- Manual cylinder changeover
- Pressure relief valve
- Alarm with audio and visual warnings
- Accommodates G & H cylinders
- Zone valve pkg. available



39550  
Zone Valve

### Product Specifications

Dimensions with Cover:	15" x 8 1/2" x 3 1/2" 38 cm x 22 cm x 9 cm
Working Pressure:	50-55 psi
Hose Length:	3 ft.
N2O Outlet:	N <sub>2</sub> O DISS
O2 Outlet:	O <sub>2</sub> DISS
Primary Voltage:	120 volts
Cable:	Category 5, Ethernet 4 twisted pr., RJ-45 end connectors

### Guardian Monitor® Manifold and Alarms with Pre-Install Kits

Order No.	Product Description	Retail List
38002	<b>Manifold with Wall Alarm System A – 2 O<sub>2</sub> + 2 N<sub>2</sub>O</b> (includes pre-install kit)	\$4,377
38003	<b>Manifold with Desk Alarm System B – 2 O<sub>2</sub> + 2 N<sub>2</sub>O</b> (includes pre-install kit)	\$4,377
38004	<b>Manifold with Wall Alarm System C – 2 O<sub>2</sub> + 1 N<sub>2</sub>O</b> (includes pre-install kit)	\$3,939
38005	<b>Manifold with Desk Alarm System D – 2 O<sub>2</sub> + 1 N<sub>2</sub>O</b> (includes pre-install kit)	\$3,939
39550	<b>Zone Valve</b> (for Guardian Monitor® Conventional)	\$1,391

Note: Zone valve required when manifold is in a remote location.

See page 35 for other manifold components.

#### Manifold Package Contents:

Manifold with pressure gauges & high/low pressure alarm switches, 3 or 4 cylinder regulators (2 O<sub>2</sub> & 1 or 2 N<sub>2</sub>O), three or four 4 ft. DISS hoses (2 O<sub>2</sub> & 1 or 2 N<sub>2</sub>O), power supply, wall or desk office control panel and cylinder restraints.

### Guardian Monitor® Manifold and Alarms without Pre-Install Kits

Order No.	Product Description	Retail List
38002-NP	Conventional Manifold/Wall Alarm System A (2+2)	\$4,245
38003-NP	Conventional Manifold/Desk Alarm System B (2+2)	\$4,245
38004-NP	Conventional Manifold/Wall Alarm System C (2+1)	\$3,805
38005-NP	Conventional Manifold/Desk Alarm System D (2+1)	\$3,805
39550	Zone Valve (for Guardian Monitor® Conventional)	\$1,391

### Guardian Monitor® Manifold and Alarms Pre-Install Kits

Order No.	Product Description	Retail List
38051	Pre-Installation Kit for Guardian Monitor® Conventional Manifold System B & D Contents: Manifold template, copper pipe risers, 100 ft. cable, outlet box for desk control panel	\$132
38052	Pre-Installation Kit for Guardian Monitor® Conventional Manifold System A & C Contents: Manifold template, copper pipe risers, 100 ft. cable, outlet box for wall control panel	\$132



38051

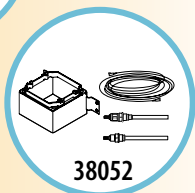

38052

Mains and branches in piping systems shall be not less than 1/2" nominal size.

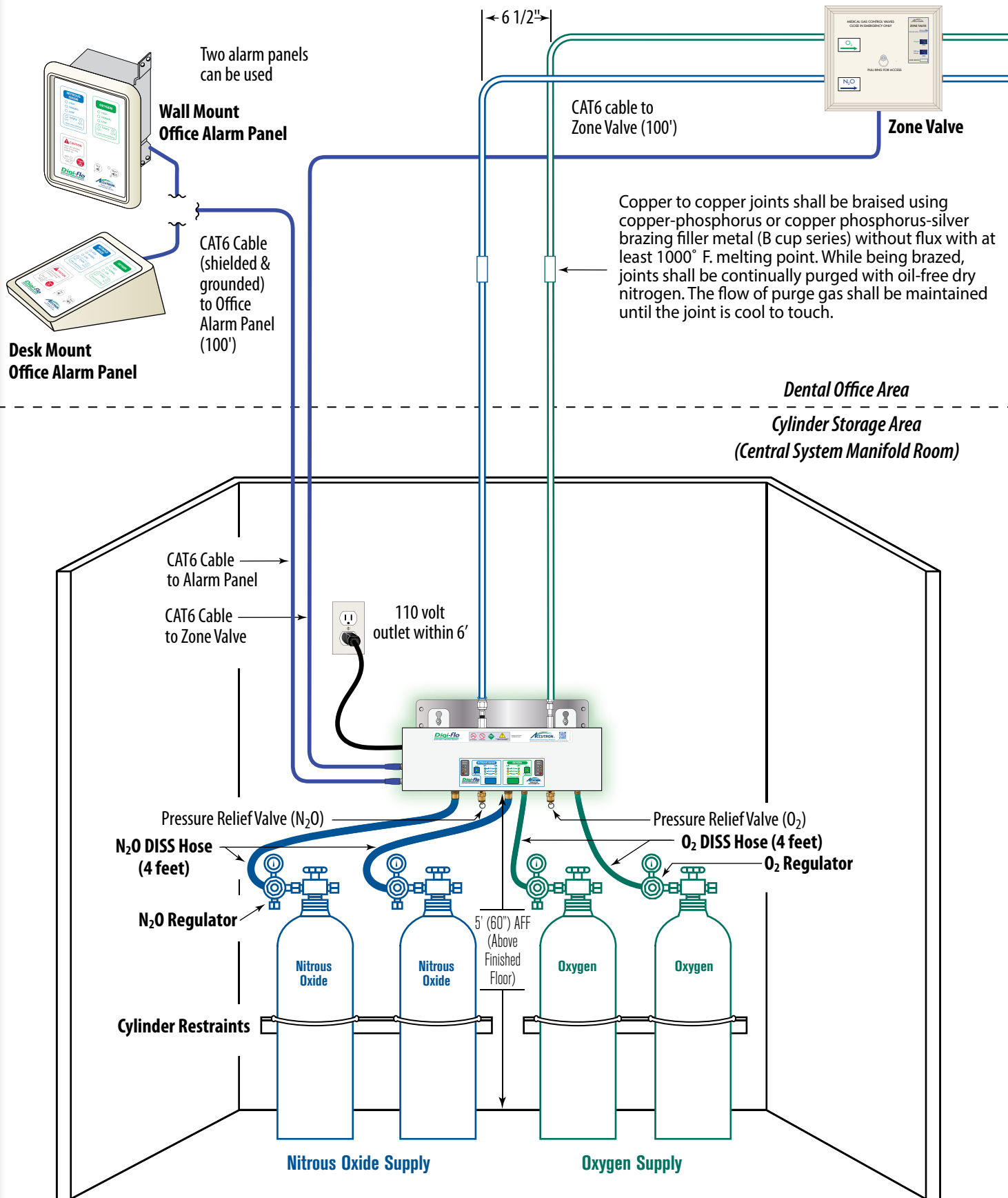

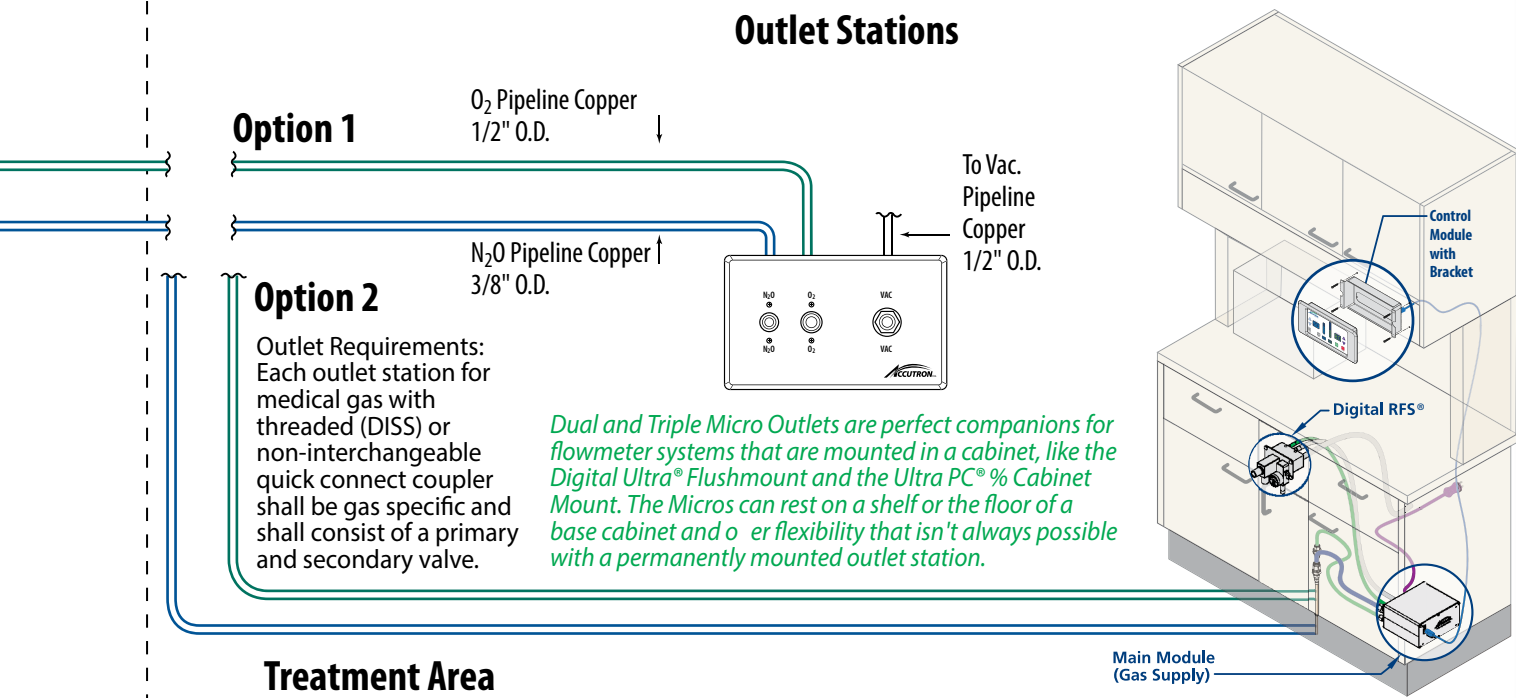

**Level III Medical Gas systems must be installed by a qualified medical gas installer and in compliance with NFPA 99 requirements.**

### Cylinder Storage Room Requirements:

No more than 3000 cubic feet of gas connected and in storage at one time (excluding nitrogen). Cylinders should be stored in a locked room or cabinet.

- A separate regulator for each gas cylinder
- A pressure relief valve set at 75 psi
- A check valve down stream of each regulator
- System line pressure set at 50 psi
- When the supply system is remote, the switchover shall be automatic

Flexible tubing must not go through wall(s) or partition(s) and have a minimum burst pressure of 1000 psi. When nonflammable gas supply (N<sub>2</sub>O-O<sub>2</sub>) cylinders are located inside building, they should be in a separate room or enclosure, and separated from the rest of the building by not less than one-hour fire-resistant construction. Two vents of not less than 72 square inches in area should be included. One vent within 6 inches of the floor and one vent within 6 inches of the ceiling. Exception: When an exterior wall cannot be provided see code for requirements. Openings between room or enclosure and interior shall be self-closing smoke and draft control, having a fire protection rating of not less than one hour.

*All information provided is intended to assist in the installation of the medical gas system. It is not intended to be complete or eliminate the need to reference NFPA 99 regulations.*

### General Piping Requirements:

Tubes, valves, fittings, outlet stations and other piping components in medical gas systems shall have been cleaned for oxygen service prior to installation. Piping shall be hard-drawn seamless medical gas tube, type K or L (ASTM B819), and bear one of the following markings: OXY, MED, OXY/MED. ACR/OXY or ACR/MED. Piping for non-flammable medical gas systems shall be suitable for oxygen service. Each length of tube shall be permanently labeled and delivered plugged and capped. Fittings, valves and other devices shall be sealed and marked. The installer shall furnish documentation certifying that all installed piping materials comply with the requirements and that the plumber has the appropriate medical gas license.

### Testing Requirements:

Piping Integrity and System Verification Final Testing include:

- Initial Pressure Test
- Blow Down
- Piping Purge
- Static Pressure Test
- Pressure Relief Test
- Cross Connection Test
- Alarm Testing for Gas System

Refer to NFPA 99. The responsible facility authority will review all inspection and testing prior to the use of all systems covered by this requirement.

*Note: At the time of this printing, NFPA 2005, 2012, and 2015 are in use in North America. It is important to consult with your local municipality to confirm which codes(s) they have currently adapted.*



### Axess™ Low Profile Nasal Masks

- Single-use
- 2 soothing scents
- Plus unscented
- Large, medium & small sizes
- 24 nasal masks per package
- Non-Latex\* components
- Made in the USA

**\*Not made with natural rubber latex**



**FREE SAMPLES!**  
 CALL US AT 800-531-2221  
 OR GO TO  
 WWW.ACCUTRON-INC.COM

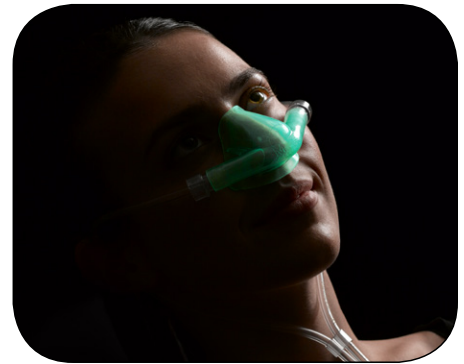

## PATIENT COMFORT AND CLINICAL EFFICIENCY – A PERFECT COMBINATION!

- Low profile – offers better visibility and easier access to patient’s mouth than other nasal masks
- Single-Use – minimizes cross-contamination; saves staff time
- Two scents (Bubblegum and Mint) and unscented for scent-sensitive patients – engages patient in mask selection
- Contoured design around mask – provides a good seal minimizing ambient nitrous oxide and gas flow into patient’s eyes
- No tube protruding into patient nostril and no tape at nose – fits comfortably and snug
- Translucent colors and clear mask – shows patient properly breathing through their nose and mask fogs upon exhalation
- Slender, lightweight scavenging circuit tubing – reduces drag and pull with patient movement diminishing mask displacement; allows an unobstructed view of the oral cavity (purchase Axess scavenging circuit separately)

### Axess™ Low Profile Nasal Mask

Order No.	Product Description	Retail List
53037-9	Small Unscented Clear	\$140
53037-12	Small Birthday Bubblegum	\$140
53037-16	Small Fresh Mint	\$140
53035-9	Medium Unscented Clear	\$140
53035-12	Medium Birthday Bubblegum	\$140
53035-16	Medium Fresh Mint	\$140
53034-9	Large Unscented Clear	\$140
53034-12	Large Birthday Bubblegum	\$140
53034-16	Large Fresh Mint	\$140

**AXESS™ Single-Use Nasal Masks (24 per pkg.)**





THE CIRCUIT CAN BE **STEAM-STERILIZED**, WHICH MEANS IT'S ENVIRONMENTALLY FRIENDLY AND COST EFFECTIVE!

The slender and lightweight tubing of the Axess Scavenging Circuit goes hand-in-hand with the design of the Axess Low Profile Mask:

- More comfortable for patients
- Increases the clinician's field of view
- Allows clinician unobstructed access to the oral cavity
- Minimizes drag and pull, so nasal mask stays in place
- Not made from natural rubber latex
- Made in the USA

And...instead of the circuit's tubing wrapping behind the patient's head and the chair, the slender tubing wraps behind the patient's ears and is secured by a slider under the chin.

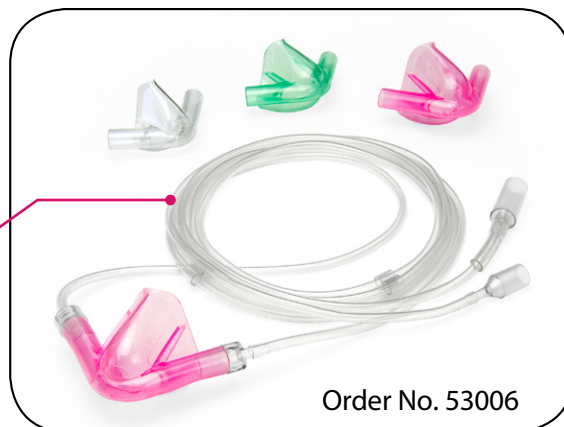

Order No. 53006

**Scavenging Circuit for RFS™ Remote Flow System and Accu-Vac™ Vacuum Controller**



Order No. 53005

**Scavenging Circuit for In-line Vacuum Controller**

## Axess™ Scavenging Circuits

Order No.	Product Description	Retail List
53005	<b>Axess™ Scavenging Circuit for In-line Vacuum Controller</b> Includes 6-foot long low profile scavenging circuit with In-line vacuum controller, complimentary low profile nasal mask assortment, adapters for connecting most non-Accutron vacuum controllers, instructions for use and reprocessing.	\$300
53006	<b>Axess™ Scavenging Circuit for RFS™ Remote Flow System and Accu-Vac™ Vacuum Controller</b> Includes 6-foot long low profile scavenging circuit (to be used with RFS and Accu-Vac™ Vacuum Controllers – not provided), complimentary low profile nasal mask assortment, adapters for connecting most non-Accutron vacuum controllers, instructions for use and reprocessing.	\$250

*See scavenging circuit parts diagram on page 37.*



**ClearView™**  
SINGLE-USE NASAL MASKS



**The nasal mask that actually demonstrates that your patient is breathing through their nose!**

**ClearView™ Nasal Masks**

- Single-use
- 6 soothing scents
- Plus unscented
- Adult & Pediatric sizes
- 12 nasal Masks per package
- Non-Latex\* components
- Made in the USA

**\*Not made with natural rubber latex**

- Mask-in-mask design minimizes ambient nitrous oxide in operator
- Clear outer mask shows “breathing through nose” respiration (condensation appears in mask)
- Soft inner mask creates improved facial seal
- Low profile expands clinical field of view
- Single-use minimizes cross-contamination; saves staff time
- Appealing colors & scents engage & relax patients
- Can be used with other brands of scavenging circuits



**Now you can actually see your patient breathing through their nose.**

**Secure Female Luer-Lok Sample Line Connection**



*Connect to capnography monitor sample line and verify patient end-tidal CO<sub>2</sub>*

**ClearView™ Single-Use Nasal Masks**

Order No.	Product Description	Retail List
33034-9	Large Adult Unscented Grey	\$70
33034-10	Large Adult Outlaw Orange	\$70
33034-14	Large Adult French Vanilla	\$70
33034-16	Large Adult Fresh Mint	\$70
33035-9	Adult Unscented Grey	\$70
33035-10	Adult Outlaw Orange	\$70
33035-12	Adult Birthday Bubblegum	\$70
33035-14	Adult French Vanilla	\$70
33035-16	Adult Fresh Mint	\$70
33037-9	Pediatric Unscented Grey	\$70
33037-10	Pediatric Outlaw Orange	\$70
33037-11	Pediatric Sassy Strawberry	\$70
33037-12	Pediatric Birthday Bubblegum	\$70
33037-17	Pediatric Groovy Grape	\$70

**ClearView™ Nasal Masks (12 per pkg.)**

**CO<sub>2</sub> Capnography Single-Use Nasal Masks**

Order No.	Product Description	Retail List
43034-9	Large Adult Unscented Grey	\$100
43034-16	Large Adult Fresh Mint	\$100
43035-9	Adult Unscented Grey	\$100
43035-14	Adult French Vanilla	\$100
43037-9	Pediatric Unscented Grey	\$100
43037-12	Pediatric Birthday Bubblegum	\$100

**ClearView™ CO<sub>2</sub> Capnography Nasal Masks (12 per pkg.)**



Order No. 43003

### Scavenging Circuit

- Low-profile assembly expands clinical field of operation
- Non-Latex\* components
- X-ray compatible system
- Steam sterilize circuit
- White finish complements clinical environment
- Accommodates most flowmeter brands
- Made in the USA

**\*Not made with natural rubber latex**



## ClearView™ Scavenging Circuits - for Standard Bag Tee

Order No.	Product Description	Retail List
43003	<b>ClearView™ Scavenging Circuit II</b> (includes Scavenging Circuit with Vacuum Control Valve, Corrugated Tube, Reservoir Bag and complimentary ClearView™ Single-Use Nasal Masks)	\$790
43005	<b>ClearView™ Scavenging Circuit I</b> (includes Scavenging Circuit with Vacuum Control Valve and complimentary ClearView™ Single-Use Nasal Masks)	\$688

## ClearView™ Scavenging Circuits - for RFS™ Remote Flow System & Accu-Vac™ Vacuum Controller

Order No.	Product Description	Retail List
43004	<b>ClearView™ Scavenging Circuit II</b> (includes Scavenging Circuit Corrugated Tube, Reservoir Bag and complimentary ClearView™ Single-Use Nasal Masks)	\$746
43006	<b>ClearView™ Scavenging Circuit I</b> (includes Scavenging Circuit and complimentary ClearView™ Single-Use Nasal Masks)	\$649

*See scavenging circuit parts diagram on page 37.*

## ClearView™ Adaptor Easy Order Guide

**Accutron's ClearView™ Nasal Masks connect effortlessly to:**

- ClearView™ Scavenging Circuits I (43005 & 43006)
- ClearView™ Scavenging Circuit II (43003 & 43004)
- Any existing PIP+® Scavenging Circuit
- Any Porter™ Brown Scavenging Circuit (no adaptor required)
- Matrix® Scavenging System (has one smooth tube on each side & comes with two connections) requires adaptor part number 35360



*Matrix®, and Porter™ are trademarks and registered trademarks of Midmark Corporation and Parker- Hannifin Corp.*



### PIP+® Nasal Masks

- Single-use
- 8 soothing scents
- Plus unscented
- 3 comfortable sizes
- Non-Latex\* components
- Made in the USA

**\*Not made with natural rubber latex**



**FREE SAMPLES!**  
 CALL US AT 800-531-2221  
 OR GO TO  
[WWW.ACCUTRON-INC.COM](http://WWW.ACCUTRON-INC.COM)

## PIP+® Single-Use Nasal Masks

Order No.	Product Description	Retail List
33015-3	Large Variety Pack 3 (Mint, Peach & Vanilla)	\$99
33015-9	Large Unscented Grey	\$99
33015-14	Large French Vanilla	\$99
33015-15	Large Perfect Peach	\$99
33015-16	Large Fresh Mint	\$99
33016-1	Medium Variety Pack 1 (Orange, Strawberry & Bubblegum)	\$99
33016-2	Medium Variety Pack 2 (Piña Colada, Vanilla & Orange)	\$99
33016-3	Medium Variety Pack 3 (Mint, Peach & Vanilla)	\$99
33016-9	Medium Unscented Grey	\$99
33016-10	Medium Outlaw Orange	\$99
33016-11	Medium Sassy Strawberry	\$99
33016-12	Medium Birthday Bubblegum	\$99
33016-13	Medium Piña Colada	\$99
33016-14	Medium French Vanilla	\$99
33016-15	Medium Perfect Peach	\$99
33016-16	Medium Fresh Mint	\$99
33017-1	Small Variety Pack 1 (Orange, Strawberry & Bubblegum)	\$99
33017-9	Small Unscented Grey	\$99
33017-10	Small Outlaw Orange	\$99
33017-11	Small Sassy Strawberry	\$99
33017-12	Small Birthday Bubblegum	\$99
33017-17	Small Groovy Grape	\$99

### Personal Inhaler Plus+® Nasal Masks (24 per pkg.)



33018

## Multi-Use Masks (steam sterilize)

Order No.	Product Description	Retail List
33018	Multi-Use Large Mask (1/ea.)	\$135
33019	Multi-Use Medium Mask (1/ea.)	\$126
33020	Multi-Use Small Mask (1/ea.)	\$114



Order No. 32007

### Scavenging Circuit

- Non-Latex\* components
- X-ray compatible system
- Steam sterilize circuit
- White finish complements clinical environment
- Accommodates most flowmeter brands

**\*Not made with natural rubber latex**

## PIP+® and Multi-Use Scavenging Circuits - for Standard Bag Tee

Order No.	Product Description	Retail List
32007	<b>PIP+® Scavenging Circuit II</b> (includes Scavenging Circuit with Vacuum Control Valve, Corrugated Tube, Reservoir Bag and Complimentary PIP+® Single-Use Nasal Masks)	\$790
33010	<b>PIP+® Scavenging Circuit I</b> (includes Scavenging Circuit with Vacuum Control Valve and complimentary PIP+® Single-Use Nasal Masks)	\$688
33011	Scavenger with Large Multi-Use Mask	\$713
33012	Scavenger with Medium Multi-Use Mask	\$713
33013	Scavenger with Small Multi-Use Mask	\$713

## PIP+® Scavenging Circuits - for RFS™ Remote Flow Systems & Accu-Vac™ Vacuum Controller

Order No.	Product Description	Retail List
32009	<b>PIP+® Scavenging Circuit II</b> (includes Scavenging Circuit, Corrugated Tube, Reservoir Bag and complimentary PIP+® Single-Use Nasal Masks)	\$746
33008	<b>PIP+® Scavenging Circuit I</b> (includes Scavenging Circuit and complimentary PIP+® Single-Use Nasal Masks)	\$649

See scavenging circuit parts diagram on page 37.

## PIP+® Adaptor Easy Order Guide

Accutron's Personal Inhaler Plus+® Nasal Masks connect effortlessly to Accutron™ Scavenging Circuit I (33008 & 33010) and Scavenging Circuit II (32007 & 32009). They also connect easily to any brand of scavenging system. To order an adaptor, please look for these identifying features and note the Accutron™ order number.

- 35000 **Porter™ Brown Scavenging System**  
Has 4 tubes – 2 ports on each side, mask within mask bearing the name "Brown."
- 35100 **Porter™ Clean Air Scavenging System**  
Has tube inside tube and wings or vacuum sweeps to draw off excess gas.
- 35325 **Matrx® Scavenging System**  
Has spiral, white tubing.

- 35350 **Matrx® Scavenging System**  
Has one smooth, white tube on each side.
- 35400 **McKesson® Scavenging System**  
Has clear mask and 1 tube on each side.
- 35500 **Accutron™ ClearView™ Scavenging System**  
Has 4 tubes - 2 ports on each side, colored & scented mask within clear outer mask.

Matrx®, McKesson® and Porter™ are trademarks and registered trademarks of Midmark Corporation, McKesson Corporation and Parker-Hannifin Corp.



## Vacuum Controllers

Order No.	Product Description	Retail List
36855	RFS™ Remote Flow System – Analog (for use with Ultra PC® % Cabinet Mount Flowmeters, and Digital Ultra® Flushmount Flowmeters with RFS™ Chairmount Kits)	\$993
56855	RFS™ Remote Flow System – Digital (for use with Digital Ultra® Flushmount without RFS™ Chairmount Kits)	\$993
56955	Accu-Vac™ Vacuum Controller (for use with Digital Ultra® Flushmount Flowmeter)	\$1,251



## Universal Cabinet Slide Mounts

Order No.	Product Description	Retail List
32015	<b>Accu-Vac™ Mount: (for Digital Ultra® Flushmount Flowmeter)</b> Universal Cabinet Slide, Accu-Vac™ Vacuum Controller (slide mounts to left, right, or under cabinet)	\$517
25043	<b>RFS™ Remote Flow System D Mounts: (for Digital Ultra® Flushmount Flowmeter)</b> Universal Light Pole Mount Kit (not shown)	\$176
32018	Universal Cabinet Slide, Digital RFS™ (slide mounts to left, right, or under cabinet)	\$517
25043	<b>RFS™ Remote Flow System A Mounts: (for Ultra PC® % Cabinet Mount Flowmeter)</b> Universal Light Pole Mount Kit (not shown)	\$176
32014	Universal Cabinet Slide, Analog RFS™ (slide mounts to left, right, or under cabinet)	\$517
32004	<b>Universal Slide Mount (for Ultra PC® % &amp; Ultra DC® Flowmeters)</b> Universal Cabinet Slide for Ultra® PC/DC with Mounting Adapter #24552 (slide mounts to left, right, or under cabinet)	\$517
32008	<b>Analog Bag Tee Mount: (for Ultra PC® % Cabinet Mount Flowmeter)</b> Universal Cabinet Slide, Analog Bag Tee (slide mounts to left, right, or under cabinet)	\$517
32019	<b>Digital Bag Tee Mount: (for Digital Ultra® Flushmount Flowmeter)</b> Universal Cabinet Slide, Digital Bag Tee (slide mounts left, right, or under cabinet)	\$517

# RFS™ Remote Flow System Chairmount Kits



Forest™ chair shown

## Chairside Delivery Systems

### RFS™ Remote Flow System Mounted at Patient Chair

- Eliminate long mixed gas and vacuum hoses draping from adjacent cabinets
- Create uncluttered, safer work zone for doctor and staff
- Minimize displacement of patient mask caused by drag/pull and weight of long hoses
- Store circuit and rubber goods when not in use



*RFS™ Remote Flow System mounts to patient chairs without drilling new holes and can be installed in the field – retrofit where possible or new construction. Kits are available for a wide variety of dental chair brands.*

### RFS™ Remote Flow System – Not So Remote!

*Beginning on page 38 see installation instructions and templates.*

*Illustrations below depict the combination of an RFS™ Chairmount Kit and a Flowmeter Package (RFS™ Chairmount Kits are to be purchased separately).*

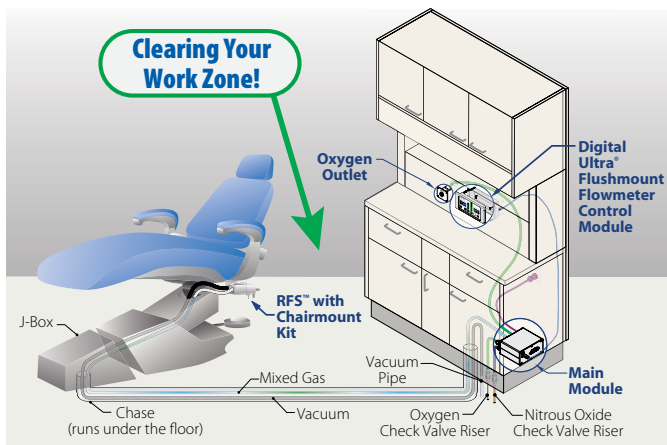

**Digital Ultra® Flushmount Flowmeter**  
56800-CHAIR  
56800-CHAIR-NS

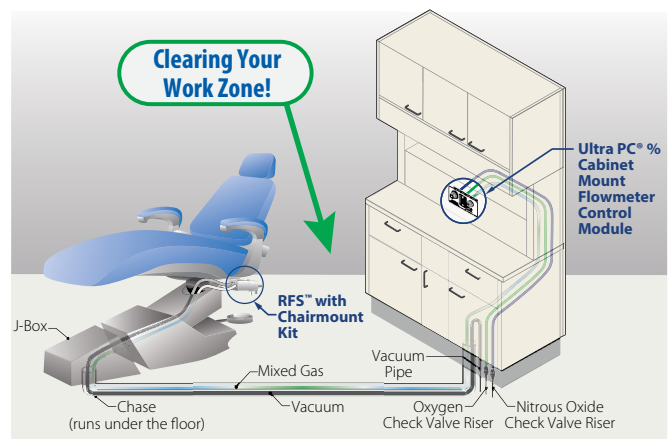

**Ultra PC® % Cabinet Mount Flowmeter**  
36800-CHAIR  
36800-CHAIR-NS



A-dec® Chairs



Forest™ Chairs



Marus® Chairs



Midmark® Chairs



Pelton &amp; Crane® Chairs

## RFS™ Remote Flow System Chairmount Kits for Chair Brands (continued)

Order No.	Product Description	Retail List
31005-1	A-dec® 1040 RFS™ Chairmount Kit	\$330
31005-2	A-dec® Decade Plus RFS™ Chairmount	\$330
31005-3	A-dec® 511 RFS™ Chairmount Kit	\$330
31005-4	A-dec® 311 RFS™ Chairmount Kit	\$330
31005-5	A-dec® 400 Series RFS™ Chairmount Kit	\$330
31005-6	A-dec® Performer Chairmount Kit	\$330
31006-1	Belmont® X-Calibur B-20N RFS™ Chairmount Kit	\$330
31006-2	Belmont® X-Calibur V B-50 RFS™ Chairmount Kit	\$330
31006-3	Belmont® Quolis™ RFS™ Chairmount Kit	\$330
31013-1	DCI Series 5 RFS™ Chairmount Kit	\$330
31009-1	DentalEZ® Simplicity RFS™ Chairmount Kit	\$330
31009-2	DentalEZ® NuSimplicity RFS™ Chairmount Kit	\$330
31009-3	DentalEZ® J/V Generation RFS™ Chairmount Kit	\$330
31008-1	Engle 300 RFS™ Chairmount Kit	\$330
31001-1	Forest™ 3900 (no extras) RFS™ Chairmount Kit	\$330
31001-2	Forest™ 3900 (touch pad) RFS™ Chairmount Kit	\$330
31001-3	Forest™ 3900 (assist pkg.) RFS™ Chairmount Kit	\$330
31001-4	Forest™ 3900 (touch pad & assist pkg.) RFS™ Chairmount Kit	\$330
31004-1	Marus MaxStar™ (no extras) RFS™ Chairmount Kit	\$330
31004-3	Marus NuStar™ (no extras) RFS™ Chairmount Kit	\$330
31002-1	Midmark® Ultra RFS™ Chairmount Kit	\$330
31002-2	Midmark® Elevance® RFS™ Chairmount Kit	\$330
31002-3	Midmark® 641 Surgery RFS™ Chairmount Kit	\$330
31010-1	OSSI Dino RFS™ Chairmount Kit	\$330
31012-1	Pediatric Bench (standard) RFS™ Chairmount Kit	\$330
31003-1	Pelton & Crane 1800 Series RFS™ Chairmount Kit	\$330
31003-2	Pelton & Crane 3000 Series RFS™ Chairmount Kit	\$330
31003-3	Pelton & Crane 1700 RFS™ Chairmount Kit	\$330

Note: Chairmount Kits do not include a Remote Flow System. See Diagrams & Templates beginning on page 38.

A-Dec®, Belmont and DentalEZ® are trademarks and registered trademarks of A-Dec Inc, Takara Belmont USA, Inc. and DentalEZ, Inc, respectively. All other product names are trademarks of their respective company's



## RFS™ Remote Flow System Chairmount Kits for Chair Brands (continued)



Royal™ Chairs

Order No.	Product Description	Retail List
31007-1	Royal Alliant RFS™ Chairmount Kit	\$330
31007-2	Royal Signet R16 RFS™ Chairmount Kit	\$330
31007-3	Royal PD2/OR2/OR3/GP2 (w/o light) RFS™ Chairmount Kit	\$330
31007-4	Royal PD2/OR2/OR3/GP2 (with light) RFS™ Chairmount Kit	\$330

See Diagrams & Templates beginning on page 38.

## Q/C Hoses & Vacuum Male Connectors

Order No.	Product Description	Retail List
33968	<b>Compatible with Accutron™ White Slim-line Outlets &amp; Porter™- type Outlets:</b> Accutron™ E-Z Q/C Hose Set*	\$251
33972	Accutron™ Vacuum Male Connector	\$132
34068	<b>Compatible with Accutron™ (silver outlets), Puritan Bennett®, McKesson® &amp; Fraser™ Outlets:</b> Accutron™ N <sub>2</sub> O-O <sub>2</sub> Q/C Hose Set*	\$251
34070	Accutron™ O <sub>2</sub> Q/C Hose*	\$132
34071	Accutron™ N <sub>2</sub> O Q/C Hose*	\$132
34081	Accutron™ Vacuum Male Connector	\$132
34168	<b>Compatible with Qxyquip™ Outlets:</b> Oxyquip™ N <sub>2</sub> O-O <sub>2</sub> Q/C Hose Set*	\$251
34072	Oxyquip™ O <sub>2</sub> Q/C Hose*	\$132
34073	Oxyquip™ N <sub>2</sub> O Q/C Hose*	\$132
34084	Oxyquip™ Vacuum Male Connector	\$132
34268	<b>Compatible with Chemtron™, NCG &amp; Coastal Outlets:</b> Chemtron™ N <sub>2</sub> O-O <sub>2</sub> Q/C Hose Set*	\$251
34085	Chemtron™ O <sub>2</sub> Q/C Hose*	\$132
34086	Chemtron™ N <sub>2</sub> O Q/C Hose*	\$132
34088	Chemtron™ Vacuum Male Connector	\$132
34368	<b>Compatible with Matrx®, Ohio &amp; Centurion Outlets:</b> Matrx® N <sub>2</sub> O-O <sub>2</sub> Q/C Hose Set*	\$251
34074	Matrx® O <sub>2</sub> Q/C Hose*	\$132
34087	Matrx® N <sub>2</sub> O Q/C Hose*	\$132
34080	Matrx® Vacuum Male Connector	\$132
34568	<b>Compatible with Schrader® Outlets:</b> Schrader® Inline N <sub>2</sub> O-O <sub>2</sub> Q/C Hose Set*	\$251
34668	Schrader® Flush N <sub>2</sub> O-O <sub>2</sub> Q/C Hose Set*	\$251

\*Specify lengths up to 6 feet

Set illustrations show only one of the two hoses included.

Puritan Bennett® and Schrader® are registered trademarks of Schrader-Bridgeport International and Covidien LP, respectively. All other product names are trademarks of their respective company's



34004

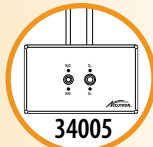

34005

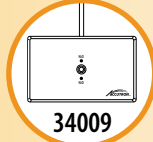

34009



34011

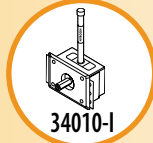

34010-I

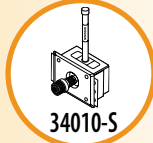

34010-S

## Recessed Outlet Stations

Order No.	Product Description	Retail List
34004	Recessed Q/C Triple Outlet (N <sub>2</sub> O-O <sub>2</sub> -Vac)*	\$647
34005	Recessed Q/C Dual Outlet (N <sub>2</sub> O-O <sub>2</sub> )	\$415
34009	Recessed Q/C O <sub>2</sub> Outlet	\$271
34011	Recessed Q/C Vacuum Outlet*	\$271
34010-I	Recessed Imperial Q/C N <sub>2</sub> Outlet	\$585
34010-S	Recessed Schrader Q/C N <sub>2</sub> Outlet	\$585

*\*Requires use of Vacuum Male Connector #33972 (page 33).*



34060



34003



34077



34076



34078-I

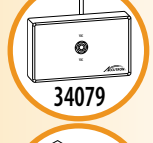

34079



34078-S



34079

## Surface Outlet Stations

Order No.	Product Description	Retail List
34003	Floor Q/C Dual Outlet (N <sub>2</sub> O-O <sub>2</sub> )	\$571
34060	Surface Q/C Triple Outlet (N <sub>2</sub> O-O <sub>2</sub> -Vac)*	\$715
34076	Surface Q/C Dual Outlet (N <sub>2</sub> O-O <sub>2</sub> )	\$459
34077	Surface Q/C O <sub>2</sub> Outlet	\$322
34079	Surface Q/C Vacuum Outlet*	\$322
34078-I	Surface Imperial Q/C N <sub>2</sub> Outlet	\$660
34078-S	Surface Schrader Q/C N <sub>2</sub> Outlet	\$660

*\*Requires use of Vacuum Male Connector #33972 (page 33).*



34012-3



34012-3-NS



34013-3



34013-3-NS



27793

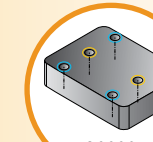

28000

## Micro Outlet Stations

Order No.	Product Description	Retail List
34012-3	Micro In-line Triple Outlet Kit – DISS* (includes Check Valve Risers, hoses and outlet station)	\$1,040
34012-3-NS	Micro In-line Triple Outlet – DISS* (for mounting within cabinetry)	\$780
34013-3	Micro In-line Dual Outlet Kit – DISS (includes Check Valve Risers, hoses and outlet station)	\$800
34013-3-NS	Micro In-line Dual Outlet Kit – DISS (for mounting within cabinetry)	\$522
28000	Micro Outlet Spacer (for Dual & Triple Micro Outlets)	\$22
27793	Oxygen Outlet – DISS with Female Q/C (for use with Digital Ultra RFS™ Chairmount Kits)	\$259

*\*Requires use of Vacuum Male Connector #33972 (page 33).*

## Digi-Flo® Manifold Accessories & Adapters

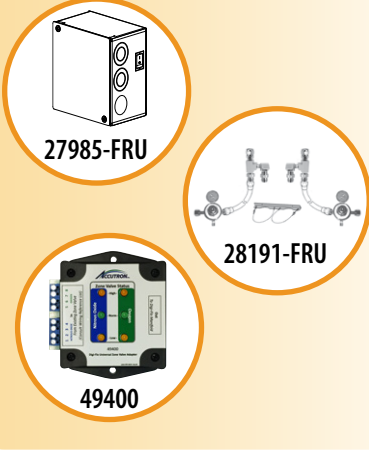

Order No.	Product Description	Retail List
27985-FRU	Digi-Flo® Optional Conduit Kit	\$276
28191-FRU	Oxygen Add-on Dual Regulator Kit	\$1,460
27954-FRU	Matrx® Manifold Adapter Kit	\$150
28406-FRU	Porter™ Manifold Adapter Kit	\$150
28408-FRU	Belmed Manifold Adapter Kit	\$150
28401-FRU	Accutron (Old Style) Manifold Adapter Kit	\$150
49400	Zone Valve Adapter Box – Converts Normally Open (NO) switches on Zone Valves to Digi-Flo®	\$500
49400-NC	Zone Valve Adapter Box – Converts Normally Closed (NC) switches on Zone Valves to Digi-Flo®	\$500

## Manifold Accessories & Components



Order No.	Product Description	Retail List
23123	Zone Valve Box Trim/Frame Assembly (for zone valve #39550)	\$219
23126	Gas Identification Labels (6 O <sub>2</sub> and 6 N <sub>2</sub> O)	\$32
23148	100 ft. CAT6 Black Cable and Connector	\$93
23189	Zone Valve Box Door/Cover (for #39550)	\$110
27224	Cylinder Room Caution Sticker	\$5
27319	Purge Fitting Set	\$82
34057	Oxygen Regulator	\$433
34058	Nitrous Oxide Regulator	\$433
34061	Oxygen Hose (DISS 3 feet)	\$124
34062	Nitrous Oxide Hose (DISS 3 feet)	\$124
34075	Cylinder Restraints (accommodates 4 cylinders)	\$248

## Oral Surgery N<sub>2</sub> & O<sub>2</sub> Manifold System Components



Order No.	Product Description	Retail List
34057	Oxygen Regulator	\$433
34061	Oxygen Hose (DISS 3 feet)	\$124
48025	Cylinder Restraints (accommodates 2 cylinders)	\$145
48075	Nitrogen Regulator	\$482
48078	Nitrogen Hose DISS (DISS 3 feet)	\$140

See quick-connect hoses and outlet stations on pages 33 & 34.



22137 &  
33014



33025 &  
33026



21178



21179



21245



21246



22099



22122



25590



25591



25592



25593

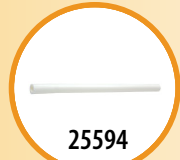

25594



26253



26254



26255



27132

## Rubber Goods

Order No.	Product Description	Retail List
22137	6-foot Corrugated Tube	\$75
33014	3-foot Corrugated Tube	\$50
33025	Reservoir Bag – 3 Liter	\$45
33026	Reservoir Bag – 2 Liter	\$45

## Scavenging Circuit Components

Order No.	Product Description	Retail List
21178	Double Connectors for PIP+ <sup>®</sup> Nasal Mask (2/pkg.)	\$45
21179	Single Connectors for PIP+ <sup>®</sup> Nasal Mask (2/pkg.)	\$45
21245	Large Y Connector	\$45
21246	Small Y Connector	\$45
22099	Scavenging Hub for PIP+ <sup>®</sup> Nasal Masks (clear disk)	\$54
22122	Vacuum Gauge (for standard bag tee) For ClearView <sup>™</sup> and PIP+ <sup>™</sup>	\$167
28530-FRU	Vacuum Gauge for Axsess In-line Scavenging Circuit	\$167
28569	Axsess <sup>™</sup> Accessory Kit (Includes: 90° Outspot Adapter, White Cap, Matr <sup>x</sup> <sup>™</sup> Scavenger Adapter, Porter <sup>®</sup> In-line Scavenger Adapter & Porter <sup>®</sup> AVS Scavenger Adapter)	\$50
28516-FRU	Axsess <sup>™</sup> RFS <sup>™</sup> & Accu-Vac <sup>™</sup> Hose Assembly	\$200
28517-FRU	Axsess <sup>™</sup> In-Line Hose Assembly	\$200
25590	Double Tubing for PIP+ <sup>®</sup> Scavenging Circuit (order 2)	\$32
25591	Axsess <sup>™</sup> Spiral Vacuum Tube – 3 1/2'	\$17
25592	Axsess <sup>™</sup> Spiral Vacuum Tube – 1 1/2'	\$17
25593	5" Large Tube for PIP+ <sup>®</sup> Scavenging Circuit (order 2)	\$17
25594	7 1/4" Small Tube for PIP+ <sup>®</sup> Scavenging Circuit (order 2)	\$17
26252	PIP+ <sup>®</sup> Scavenging Plug	\$22
26253	Tube Slide Double	\$32
26254	Single Vacuum Connector	\$17
26255	90° Elbow (creates 90° angle off flowmeter for attachment of scavenging circuit)	\$25
27132	6' Spiral Vacuum Tube (for RFS <sup>™</sup> Scavenging Circuit)	\$32
27693-FRU	Double Tubing for ClearView <sup>™</sup> Scavenging Circuit (order 2)	\$32

See page 37 for scavenging circuit parts diagrams.

## Axess™ Scavenging Circuit Components Diagram (standard in-line vacuum)

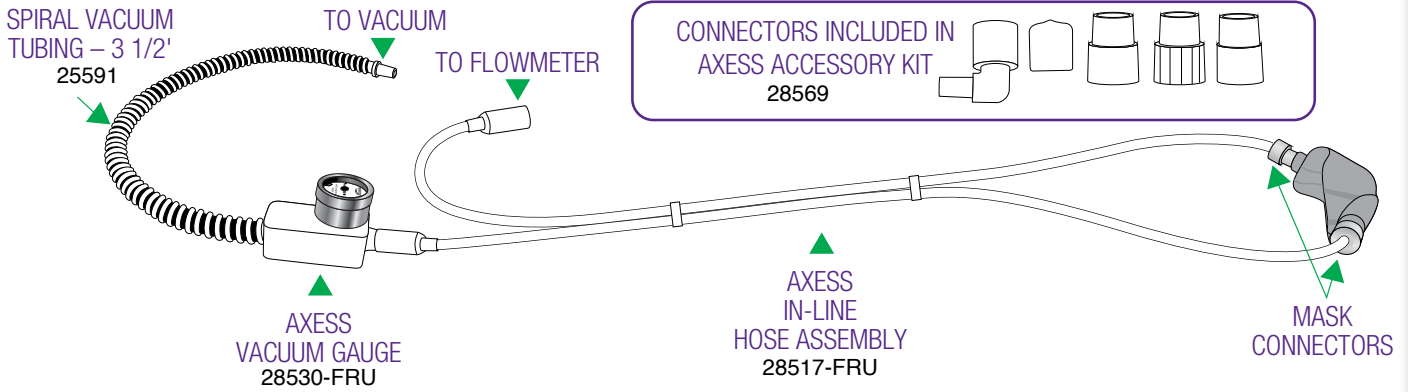

**Note:** For Axess™ Scavenging Circuits for Remote Flow System (RFS™) and Accu-Vac™ Vacuum Controller, part 28517-FRU is replaced with 28516-FRU, and parts 25591 and 28530-FRU are not included.

## ClearView™ Scavenging Circuit Components Diagram (standard bag tee)

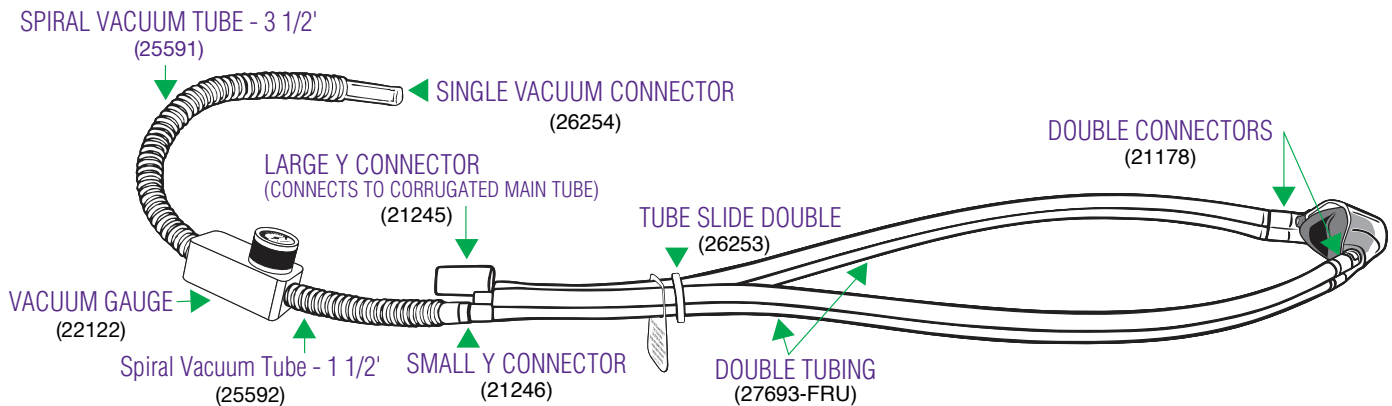

Nasal Masks, Scavenging Circuit & Rubber Goods are Not made with natural rubber latex!

**Note:** For ClearView™ Scavenging Circuits for RFS™ Remote Flow System and Accu-Vac™ Vacuum Controller, parts 25591, 22122 and 25592 are replaced with a 6' Spiral Vacuum Tube (part 27132).

## PIP+® Scavenging Circuit Components Diagram (standard bag tee)

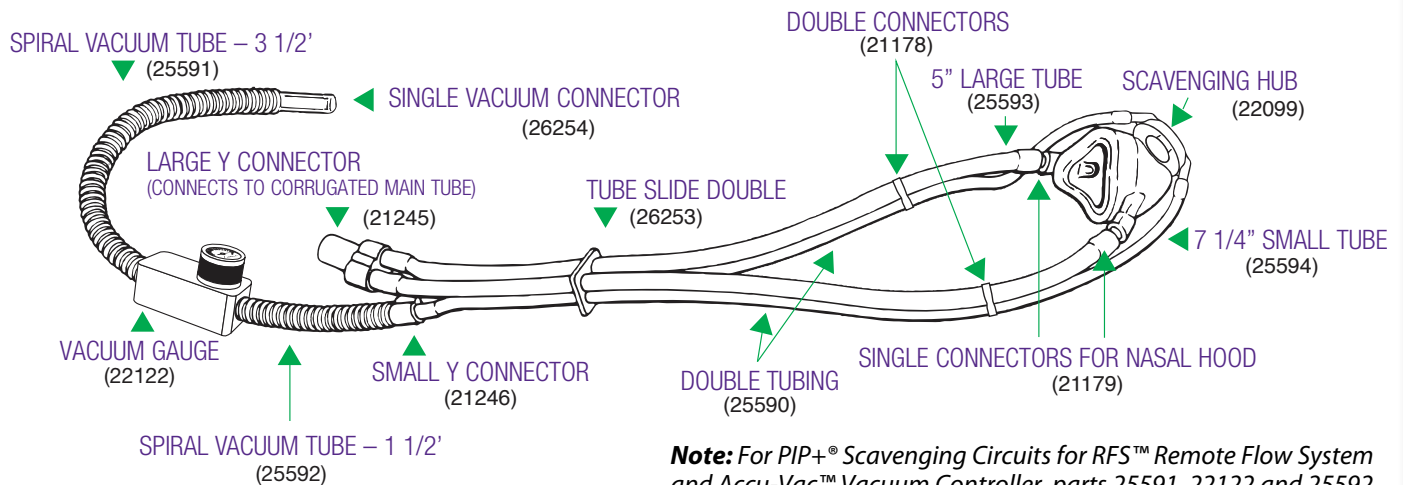

**Note:** For PIP+® Scavenging Circuits for RFS™ Remote Flow System and Accu-Vac™ Vacuum Controller, parts 25591, 22122 and 25592 are replaced with a 6' Spiral Vacuum Tube (part 27132).

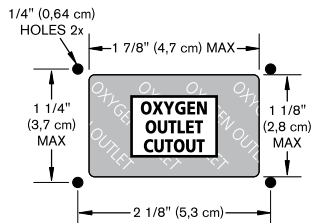

Template not to scale.

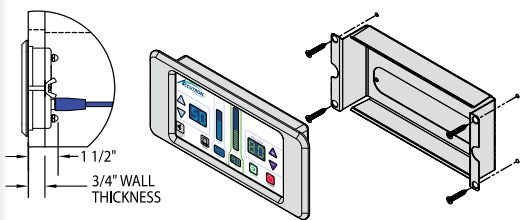

See installation illustration on page 39.

## Digital Ultra® Flushmount Flowmeter 56800-CHAIR

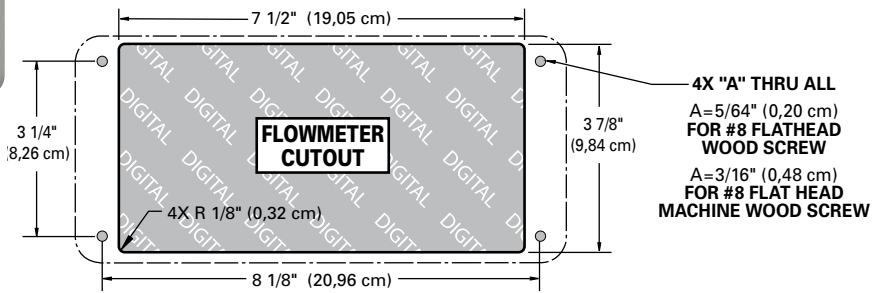

Template not to scale.

### 1) In advance of construction:

- Provide for tubing chase from flowmeter location to chair J-Box.
- Install Vacuum, Oxygen, and Nitrous Oxide risers.

### 2) Installation:

- Ensure cut-outs for the flowmeter and oxygen outlet are located correctly.
- Mount Control Module Bracket, with long slot down. Feed cable through the slot. Connect cable to controller and press controller into bracket. Make sure cable is not pinched. To remove controller from the bracket, insert screwdriver into slot at bottom corner of controller and pry outward.
- Pull the Mixed Gas and Vacuum lines up to the Remote Flow System mounting location on the chair.
- Install Remote Flow System to chair.  
*(Requires purchase of brand-specific Chairmount Kit - see page 31-33).*
- Complete connections of all hoses.

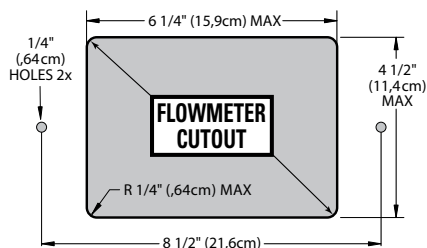

Template not to scale.

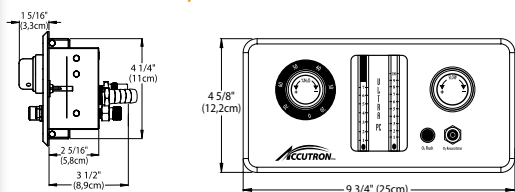

## Ultra PC® % Cabinet Mount 36800-CHAIR

### 1) In advance of construction:

- Provide for tubing chase from flowmeter location to chair J-Box.
- Install Vacuum, Oxygen, and Nitrous Oxide risers.

### 2) Installation:

- Ensure cut-out for the flowmeter is located correctly.
- Mount Ultra PC® Flowmeter through cutout, install wing nuts, and connect hoses to risers.
- Pull the Mixed Gas and Vacuum lines up to the Remote Flow System mounting location on the chair.
- Install Remote Flow System to chair.  
*(Requires purchase of brand-specific Chairmount Kit - see page 31-33).*
- Complete connections of all hoses.

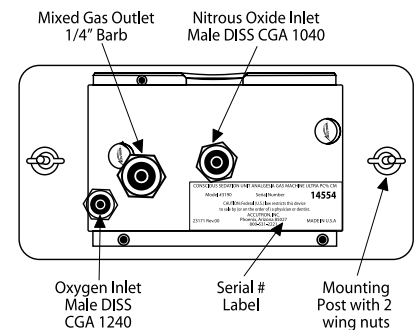

Digital Ultra® Flushmount Flowmeter with RFS™ Mounted in Cabinet

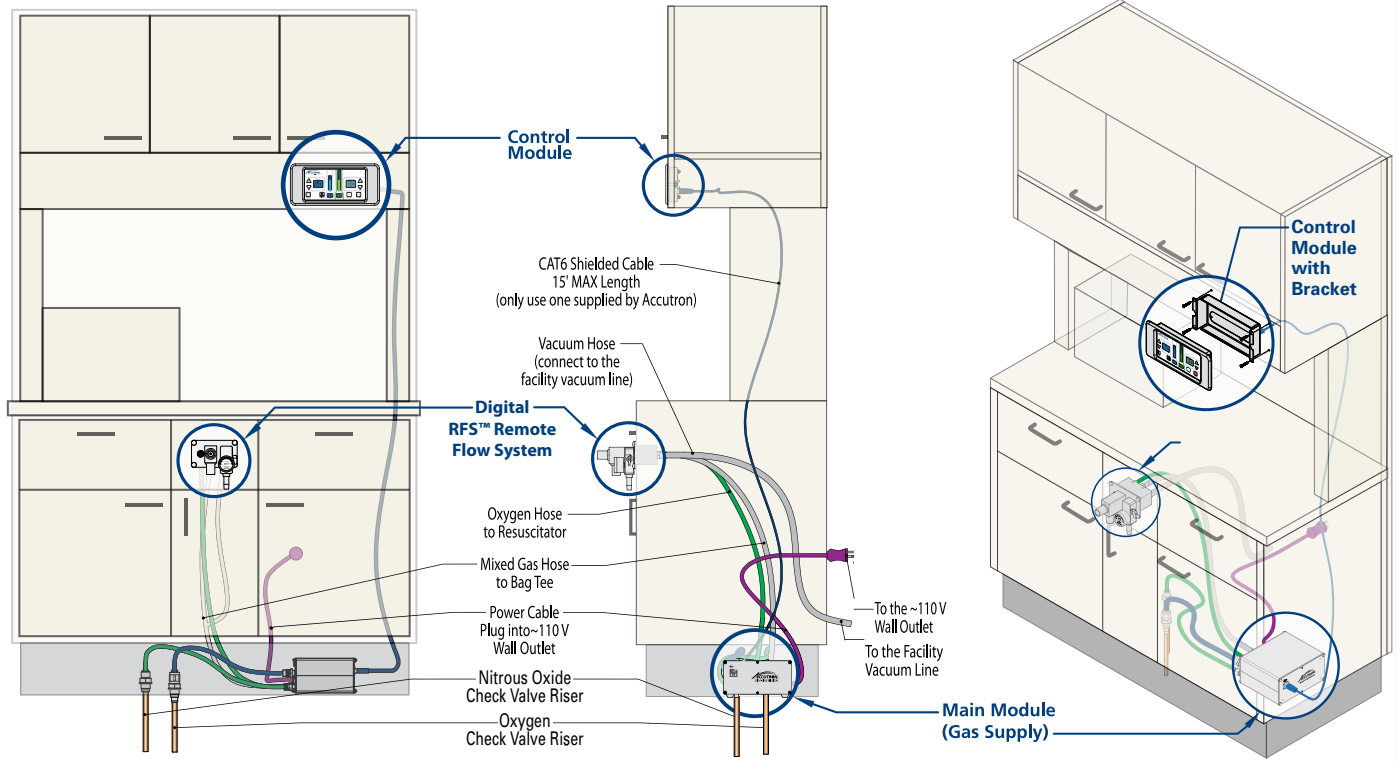

In-cabinet illustrations are specific to 56800 Digital Ultra® Flushmount with RFS™ Remote Flow System Vacuum Controller.

Bracket is included with flowmeter.

Digital Ultra® Flushmount Flowmeter Template

Digital Ultra® Flushmount Flowmeter

Slimline design separates control module from gas supply module and offers:

- More accessible cabinet space
- Flexible installation choices
- Mounting in wall as an option

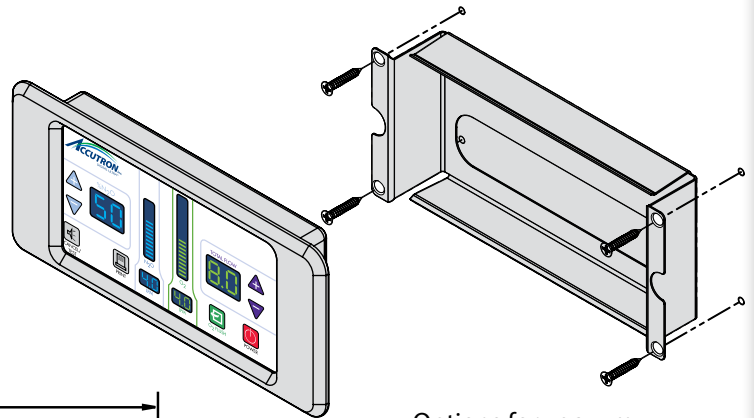

Options for vacuum system controllers include: Standard Bag Tee, Accu-Vac™ or RFS™ Remote Flow System.

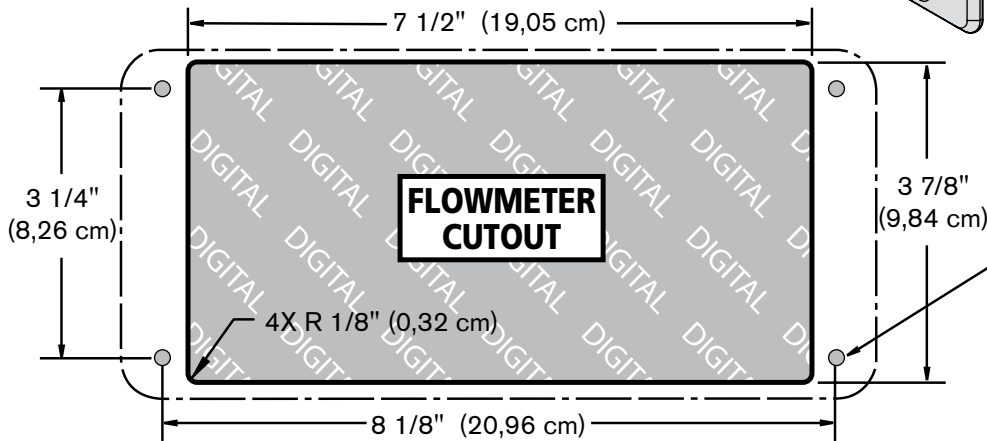

**4X "A" THRU ALL**  
 A=5/64" (0,20 cm)  
**FOR #8 FLATHEAD WOOD SCREW**  
 A=3/16" (0,48 cm)  
**FOR #8 FLAT HEAD MACHINE WOOD SCREW**

Cut-out dimensions not to scale.

## Ultra PC® % Cabinet Mount Flowmeter Diagram



### Ultra PC® % Cabinet Mount Flowmeter

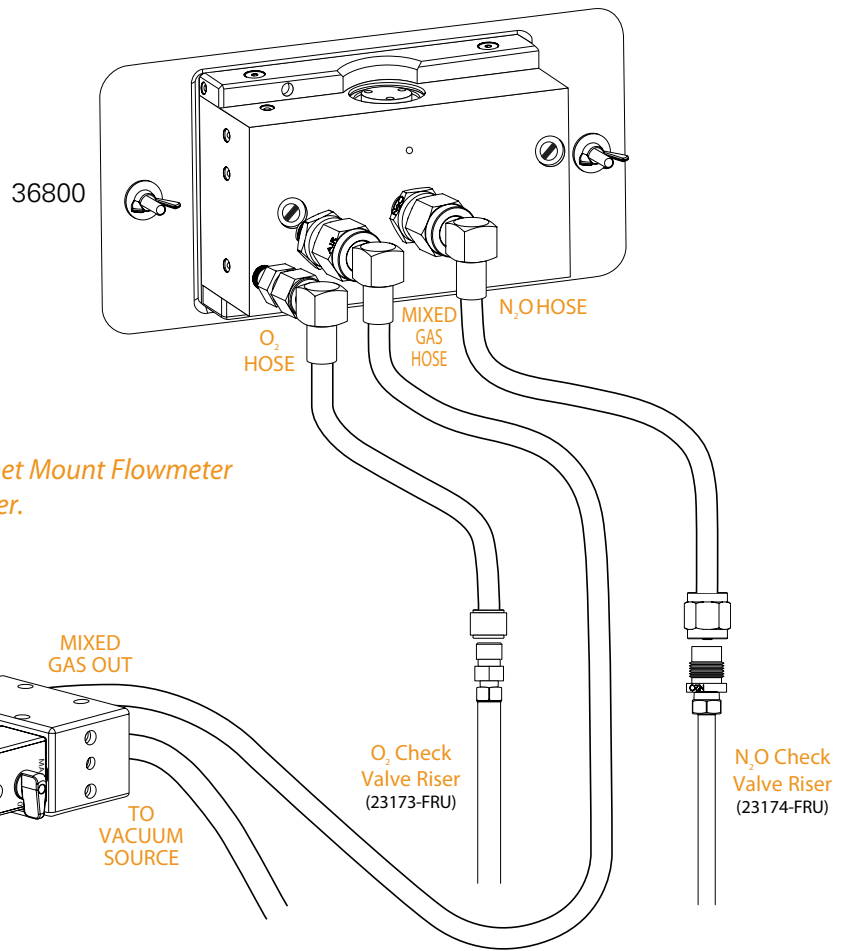

Diagram is specific to 36800 Ultra PC® % Cabinet Mount Flowmeter with RFS™ Vacuum Controller.

## Ultra PC® % Cabinet Mount Flowmeter Template

### Ultra PC® % Cabinet Mount Flowmeter

- Vertical dimension of cut is 4 1/2" MAX
- Horizontal dimension of cut is 6 1/4" MAX
- Minimum Depth is 3 1/2"

Options for vacuum system controllers include: Standard Bag Tee and RFS™ Remote Flow System.

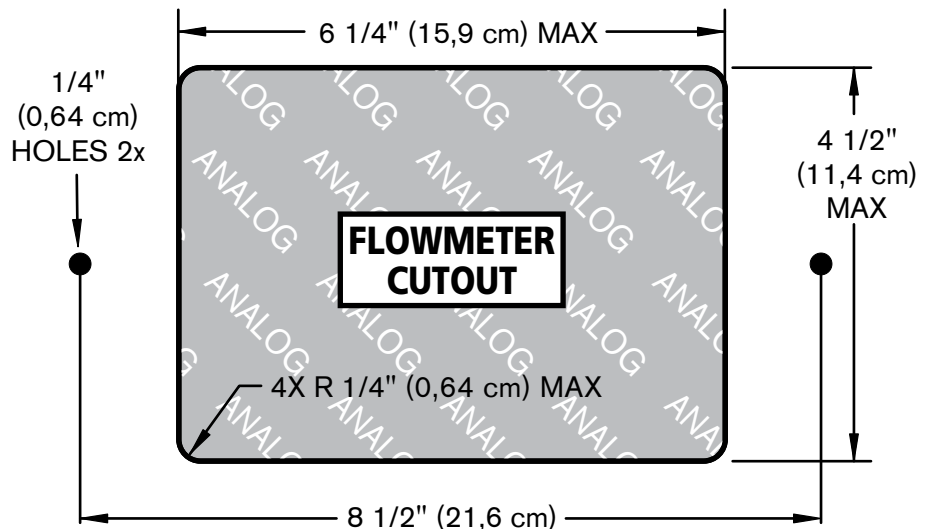

Cut-out dimensions not to scale.



## Micro In-Line Triple Outlet Template

Order Nos.  
34012-3  
34012-3-NS

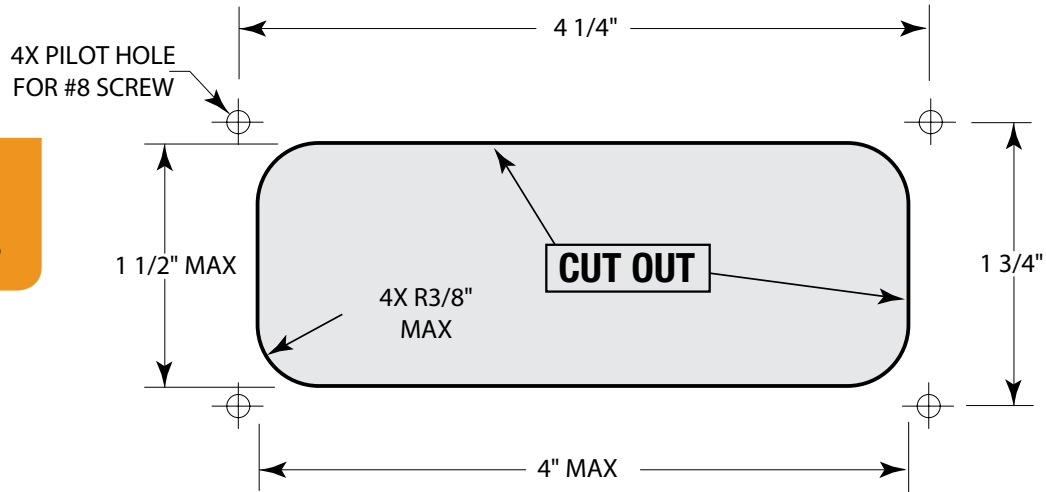

*Cut-out dimensions not to scale.*

## Micro In-Line Dual Outlet Template

Order Nos.  
34013-3  
34013-3-NS

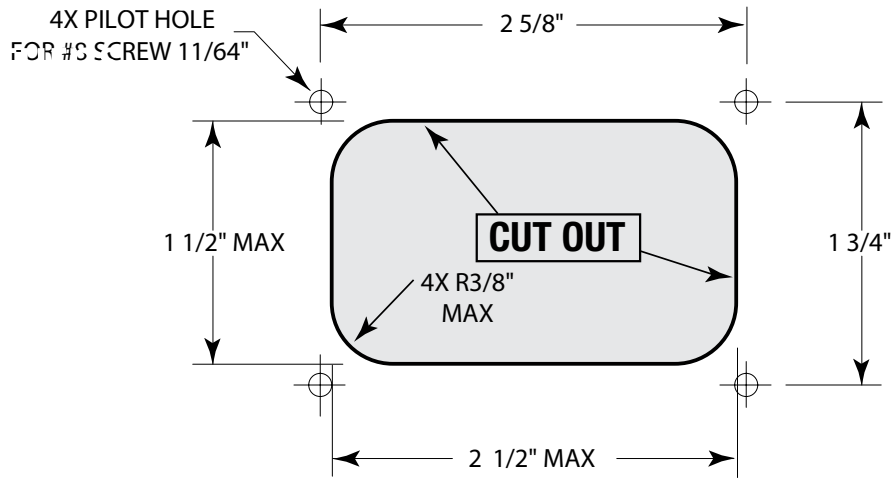

*Cut-out dimensions not to scale.*

## Recessed Outlet Station Template

Order Nos.  
34004  
34005  
34009  
34010-I  
34010-S  
34011

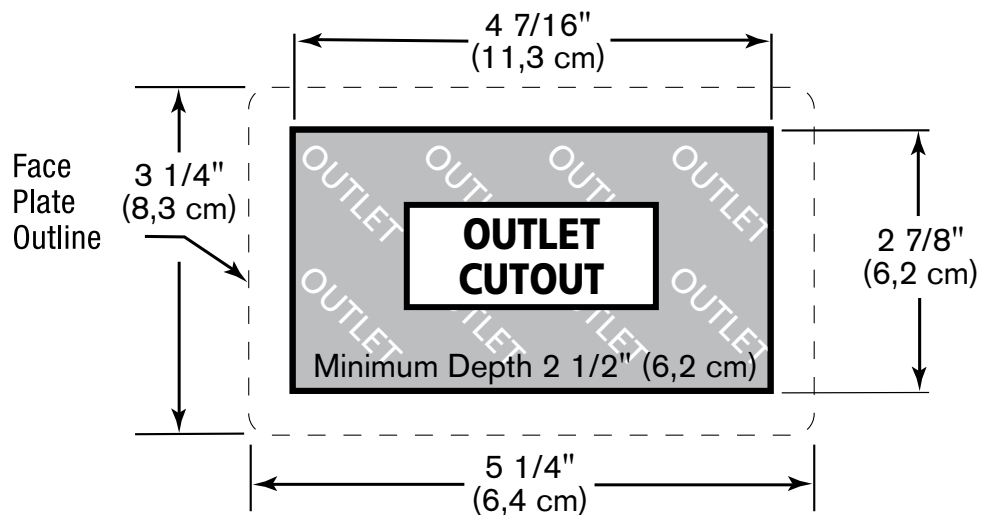

*Cut-out dimensions not to scale.*

### ACCUTRON™ 2-YEAR FLOWMETER LIMITED WARRANTY

IF AN ACCUTRON™ FLOWMETER NEEDS TO HAVE REPAIR WORK OR REPLACEMENT PARTS DURING THE 2-YEAR WARRANTY PERIOD DUE TO MANUFACTURING DEFECTS, ACCUTRON™ WILL PROVIDE THE PARTS AND LABOR AT NO CHARGE. THE FLOWMETER OWNER IS RESPONSIBLE ONLY FOR A \$35.00 SHIPPING AND HANDLING FEE, WHICH WILL BE ASSESSED EACH TIME A FLOWMETER IS RETURNED TO ACCUTRON™ FOR WARRANTY WORK.

#### WARRANTY TERMS

Limited Warranty and Disclaimer: Accutron™ (“Seller”) warrants that its product will be free from manufacturing defects subject to the terms, conditions, and limitation set forth hereinafter, for a period of 2 years for flowmeters and 1 year for other equipment products. Seller’s obligations under this limited warranty are contingent on Buyer’s full payment of the product purchase price. Except as specifically set forth above, Seller and its affiliates make no warranties, expressed or implied, and specifically disclaim any warranties of merchantability or fitness for a particular purpose.

The liability of Seller and its affiliates for any claims, losses, damages, or expenses from any cause whatsoever (including acts or omissions of third parties) regardless of the form of the action, whether in tort, contract, or otherwise, shall not exceed the repair cost, replacement cost, or purchase price of the product that directly gives rise to the claim. Seller and its affiliates shall not be liable for any incidental, special, reliance, consequential, or indirect loss or damage rising out of this agreement or the products. As used in this paragraph, consequential damages include, but are not limited to, lost profits, lost revenues, property damage, personal injury damage to the Purchaser or third parties, loss of business or profits, and/or loss of business reputation. It is the sole responsibility of Purchaser to determine the suitability of the products for the Purchaser’s intended use. Seller’s obligation to repair, replace or refund, as set forth above shall be Buyer’s exclusive remedy.

This warranty constitutes the entire warranty. This warranty and Seller’s liability hereunder shall be construed according to the laws of the State of Arizona without regard to conflict of law principles.

To activate the Flowmeter Warranty, complete and mail the warranty registration card that accompanies Flowmeter.

Accutron™ warranties are subject to the following conditions: Accutron™ products and equipment are warranted to be free from defects in material and workmanship under normal use and service, including all component parts. This warranty shall not apply to defects resulting from accidents, alterations, or misuse. If modifications have affected the operation of the product to render it faulty, this warranty shall be void. This warranty shall be void if any part not of Accutron’s manufacture or supply has been incorporated into the product.

THIS WARRANTY IS GIVEN IN PLACE OF ALL OTHER WARRANTIES EXPRESSED OR IMPLIED, OF MERCHANTABILITY, FITNESS FOR A PARTICULAR PURPOSE OR OTHERWISE.

No statement or claim about the product by any employee, agent, representative or dealer of Accutron™ shall constitute a warranty by Accutron™ or give rise to any liability or obligation of Accutron™.

#### Warranty and Returned Goods Policy

All warranty resolution issues and merchandise returns will be handled through the local authorized Accutron™ distributor. Contact distributor where unit was purchased. Custom hoses cannot be returned.

#### Repair Service Policy

All service issues will be handled through the local authorized Accutron™ distributor. Contact distributor where unit was purchased.

#### Assistance

For Assistance, contact your local dental distributor or call Accutron™ Customer Service at:

Toll-free: (800) 531-2221

Local: (623) 780-2020

Fax: (623) 780-0444

Hours of operation: 7:00 AM – 4:30 PM MST

Service ship-to address:

Accutron

1733 W. Parkside Lane

Phoenix, AZ 85027

Visit our website:

[www.accutron-inc.com](http://www.accutron-inc.com)





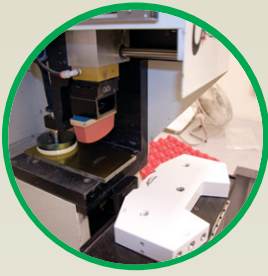

YEARS OF INNOVATION



*Productivity*

*Initiative*

*Innovation*

*Integrity*

*Ethics*

## Quality Statement

*It is Accutron's policy to:*

- Provide products and services that meet or exceed our customers' requirements.
- Meet all regulatory requirements.
- Comply with the requirements of our quality management system and maintain its effectiveness.

Accutron™ products are designed, manufactured and inspected under comprehensive Quality System certified to meet ISO-13485 and 93/42/EEC requirements



Proud Participant

*DentaCheques*

A Program of  
Dental Lifeline  
Network

**CROSSTEX**<sup>®</sup>  
A CANTEL MEDICAL COMPANY

**ACCUTRON**<sup>™</sup>  
Nitrous Oxide/Oxygen Sedation

1733 Parkside Lane • Phoenix, AZ 85027  
Toll-free: 800.531.2221 • Local Phone: 623.780.2020 • Fax: 623.780.0444

[www.accutron-inc.com](http://www.accutron-inc.com)

Part No. 25969 - Rev. 19 - 03/2017